

konusulan
the spoken kalite...
quality...

2019

ÜRÜN BROŞÜRÜ
PRODUCT BROCHURE



www.akkocom.tr

 **AKKO®**



1986 yılında Abdullah KARAKUŞ tarafından kurulan AKKO Oto. Mak. Hırd. San. Tic. Ltd. Şti. Tornalama Takımları, Diş ve Kanal Açma Takımları, Delik Delme Takımları, Frezeleme Takımları ve Özel Takımları üretmektedir. Şu an 8000 m² ye yakın bir alanda Türkiye, Japonya, Almanya, İsviçre gibi ülkelerin ürettikleri son teknoloji tezgah ve ekipmanlarıyla yıllık 300.000 adet üretim kapasitesiyle, standart 7000 çeşit takım üretimi yapmaktadır. Avrupa, Asya, Afrika, Güney Amerika ve Orta Doğu'da şimdilik 70 ülkeye ürün sevkiyatına devam etmekte olup 200.000 adet civarında üretilmiş ürün stoklarında mevcuttur. Firmaya, özel üretilen çelik hammadde işleme girer ve bütün üretim süreci bünyesinde gerçekleşir. Çeliğin işlenmesi, ısıl işleme, üzerindeki kaplama ve her türlü üretim süreci bir entegre tesis olan AKKO'da gerçekleşir.



We as AKKO Oto. Mak. Hird. San. Tic. Ltd. Şti, which has been founded by Abdullah KARAKUŞ in 1986, produce Turning Tool Holders, Threading and Grooving Tool Holders, U-Drills, Milling Tool Holders and Precision Tool Holders (OEM Tool Holders). We produce standard 7000 kinds of tool holders with production capacity of 300.000 pieces per annum in an area about 8000 square meter. We are going on exporting 70 countries including European, Asian, African, Asian, South American Countries and Middle East Countries. We keep ready about 200.000 pieces produced products in our stock. Steel Raw materials that we make produced especially for us are delivered our factory and all production process are made in our factory. All kind of process from machining of steel to heat treatment and coating on our tools are made in our integrated factory AKKO.

Dış Çap Tornalama Katerleri / External Turning Toolholders

 <p>75° TCBNR / L</p>	<p>T Sistem/T System</p> <p>2525 M16</p>	 <p>75° TCKNR / L</p>	<p>T Sistem/T System</p> <p>2020 K12 2525 M12 3232 P12 2525 M16 3232 P16</p>	 <p>95° TCLNR / L</p>	<p>T Sistem/T System</p> <p>2020 K12 2525 M12 3232 P12 4040 S12 5050 S12 2525 M16 3232 P16</p>
 <p>50° TCMNN</p>	<p>T Sistem/T System</p> <p>1616 H12 2020 K12 2525 M12 3232 P12 2525 M16 3232 P16</p>	 <p>40° TCZNN</p>	<p>T Sistem/T System</p> <p>2020 K12 2525 M12 3232 P12 2525 M16 3232 P16</p>	 <p>107.5° TDHNR / L</p>	<p>T Sistem/T System</p> <p>2525 M11 2020 K15 2525 M15 3232 P15</p>
 <p>93° TDJNR / L</p>	<p>T Sistem/T System</p> <p>1616 H11 2020 K11 2525 M11</p>	<p>2020 K15 2525 M15 3232 P15 4040 S15</p>	<p>2020 K1504 2525 M1504 3232 P1504 4040 S1504</p>	 <p>62.5° TDNNN</p>	<p>T Sistem/T System</p> <p>1616 H11 2020 K11 2525 M11 2020 K15 2525 M15 3232 P15</p>
 <p>45° TSDNN</p>	<p>T Sistem/T System</p> <p>1616 H12 2020 K12 2525 M12 3232 P12 3232 P15</p>	 <p>75° TSKNR / L</p>	<p>T Sistem/T System</p> <p>2020 K12 2525 M12 3232 P12 3232 P15</p>	 <p>45° TSSNR / L</p>	<p>T Sistem/T System</p> <p>2020 K12 2525 M12 3232 P12 2525 M15 3232 P15</p>
 <p>60° TTENN</p>	<p>T Sistem/T System</p> <p>2020 K16 2525 M16 3232 P16 2525 M22 3232 P22</p>	 <p>90° TTGNR / L</p>	<p>T Sistem/T System</p> <p>2020 K16 2525 M16 3232 P16 2525 M22 3232 P22</p>	 <p>93° TTJNR / L</p>	<p>T Sistem/T System</p> <p>2020 K16 2525 M16 3232 P16 2525 M22 3232 P22</p>
 <p>107.5° TVHNR / L</p>	<p>T Sistem/T System</p> <p>2020 K16 2525 M16 3232 P16</p>	 <p>93° TVJNR / L</p>	<p>T Sistem/T System</p> <p>2020 K16 2525 M16 3232 P16</p>	 <p>72.5° TVVNN</p>	<p>T Sistem/T System</p> <p>2020 K16 2525 M16 3232 P16</p>



T Sistem/T System

1616 H06
2020 K06
2525 M06
2020 K08
2525 M08
3232 P08
4040 S08

95° **TWLNR / L**



M Sistem/M System

2020 K16
2525 M16
3232 P16
2525 M22
3232 P22
4040 S22

60° **MTENN**



M Sistem/M System

2020 K16
2525 M16
3232 P16
2525 M22
3232 P22
4040 S22

93° **MTJNR / L**



M Sistem/M System

1616 H06
2020 K06
2525 M06

2020 K08
2525 M08
3232 P08

95° **MWLNR / L**



M Sistem/M System

1616 H06
2020 K06
2525 M06

2020 K08
2525 M08
3232 P08

50° **MWMNN**



P Sistem/P System

2020 K12C
2525 M12C
3232 P12C
2525 M16C
3232 P16C

3232 P19C
4040 S19C
4040 S25C

75° **PCBNR / L**



P Sistem/P System

1616 H09
2020 K09
2525 M09
1616 H12
2020 K12C
2525 M12C
3232 P12C

2525 M16C
3232 P16C
2525 M19C
3232 P19C
4040 S19C
4040 S25C
5050 S25C

95° **PCLNR / L**



P Sistem/P System

2020 K12C
2525 M12C
3232 P19C
4040 S19C
4040 S25C

50° **PCMNN**



P Sistem/P System

1616 H11
2020 K11
2525 M11
2020 K15C
2525 M15C
3232 P15C
4040 S15C

93° **PDJNR / L**



P Sistem/P System

1616 H11
2020 K11
2525 M11
2020 K15C
2525 M15C
3232 P15C

62.5° **PDNNN**



P Sistem/P System

1616 H09
2020 K12C
2525 M12C
3232 P12C
2525 M15C
3232 P15C

3232 P19C
4040 S19C
4040 S25C
5050 S25C

75° **PSBNR / L**



P Sistem/P System

1616 H09
2020 K12C
2525 M12C
3232 P12C

2525 M15C
3232 P19C
4040 S25C

45° **PSDNN**



P Sistem/P System

2020 K09
2020 K12C
2525 M12C
3232 P12C
2525 M15C
3232 P15C

3232 P19C
4040 S19C
4040 S25C
5050 S25C

75° **PSKNR / L**



P Sistem/P System

1616 H09
2020 K09
2020 K12C
2525 M12C

3232 P12C
3232 P19C
4040 S19C
4040 S25C

45° **PSSNR / L**

Dış Çap Tornalama Katerleri / External Turning Toolholders

 <p>P Sistem/P System</p> <p>1616 H16 2020 K16 2525 M16 3232 P16 2525 M22C 3232 P22C</p> <p>90° PTFNR / L</p>	 <p>P Sistem/P System</p> <p>1616 H16 2020 K16 2525 M16 2525 M22C 3232 P22C</p> <p>90° PTGNR / L</p>	 <p>P Sistem/P System</p> <p>1616 H16 2020 K16 2525 M16 3232 P16 2525 M22C 3232 P22C</p> <p>93° PTJNR / L</p>
 <p>P Sistem/P System</p> <p>1616 H16 2020 K16 2525 M16 3232 P16 2525 M22C 3232 P22C</p> <p>60° PTTNR / L</p>	 <p>P Sistem/P System</p> <p>1616 H06 2020 K06 2525 M06 1616 H08 2020 K08C 2525 M08C 3232 P08C</p> <p>95° PWLNR / L</p>	 <p>C Sistem/C System</p> <p>2020 K16 2525 M16 3232 P16 4040 S16</p> <p>93° CKJNR / L</p>
 <p>C Sistem Seramik C System Ceramic</p> <p>2525 M1207C 3232 P1207C 2525 M1607C</p> <p>95° CCLNR / L</p>	 <p>C Sistem Seramik C System Ceramic</p> <p>2525 M06CV 3225 P06CV 4040 S06CV</p> <p>-° CRDCN</p>	<p>2525 M09CV 3225 P09CV 4040 S09CV</p> <p>2525 M12CV 3225 P12CV 4040 S12CV</p>
 <p>C Sistem Seramik C System Ceramic</p> <p>2525 M1107C 2525 M1507C 3232 P1507C</p> <p>93° CDJNR / L</p>	 <p>C Sistem Seramik C System Ceramic</p> <p>2525 M1107C</p> <p>62.5° CDNN</p>	 <p>C Sistem Seramik C System Ceramic</p> <p>2525 M1207C 3232 P1207C</p> <p>45° CSDNN</p>
 <p>C Sistem Seramik C System Ceramic</p> <p>2525 M1207C 3232 P1207C</p> <p>75° CSKNR / L</p>	 <p>C Sistem Seramik C System Ceramic</p> <p>2525 M1207C 3232 P1207C</p> <p>75° CSRNR / L</p>	 <p>C Sistem Seramik C System Ceramic</p> <p>2525 M1207C 3232 P1207C</p> <p>45° CSSNR / L</p>
 <p>C Sistem Seramik C System Ceramic</p> <p>2525 M1607C 3232 P1607C</p> <p>93° CTJNR / L</p>	 <p>S Sistem/S System</p> <p>0808 E06 1010 E06</p> <p>1212 F09 1616 H09 2020 K09</p> <p>2020 K12 2525 M12-Z 2525 M12</p> <p>90° SCACR / L</p>	

 <p>50° SCMCN</p>	<p>S Sistem/S System</p> <p>0808 E06 1010 E06 1212 F06 1212 F09</p> <p>1616 H09 2020 K12 2525 M12</p>	 <p>95° SCLCR / L</p>	<p>S Sistem/S System</p> <p>0808 E06 1010 E06 1010 E09 1212 F09 1616 H09 2020 K09</p> <p>2525 M09 1616 H12 2020 K12-Z 2020 K12 2525 M12-Z 2525 M12</p>	
 <p>107.5° SDHCR / L</p>	<p>S Sistem/S System</p> <p>0808 E07 1010 E07 1212 F07 1616 H07 1616 H11 2020 K11 2525 M 11 3232 P11</p>	 <p>93° SDJCR / L</p>	<p>S Sistem/S System</p> <p>0808 E07 1010 E07 1212 F07 1616 H07 1616 H11 2020 K11 2525 M 11 3232 P11</p>	 <p>62.5° SDNCN</p> <p>S Sistem/S System</p> <p>0808 E07 1010 E07 1212 F07 1616 H07 1616 H11 2020 K11 2525 M 11 3232 P11</p>
 <p>-° SRDCR / L</p>	<p>S Sistem/S System</p> <p>3232 P12C</p>	 <p>-° SRDCN</p>	<p>S Sistem/S System</p> <p>1616 H06 2020 K06 2525 M06 1616 H08C 2020 K08C 2525 M08C</p>	<p>S Sistem/S System</p> <p>1616 H10C 2020 K10C 2525 M10C 3232 P10C 2020 K12C 2525 M12C 3232 P12C</p> <p>2525 M16C 3232 P16C 2525 M20C 3232 P20C 3232 P25C 3232 P32C</p>
 <p>-° SRGCR / L</p>	<p>S Sistem/S System</p> <p>1616 H06 2020 K06 1616 H08C 2020 K08C 2525 M08C</p>	<p>S Sistem/S System</p> <p>1616 H10C 2020 K10C 2525 M10C 3232 P10C</p> <p>2020 K12C 2525 M12C 3232 P12C</p>	 <p>20° SRHCR / L</p> <p>S Sistem/S System</p> <p>2525 K06 2525 K08 2525 K10 2525 K12 2525 K16</p>	
 <p>-° SRXCR / L</p>	<p>S Sistem/S System</p> <p>3232 X08C 3232 X10C 3232 X12C</p>	 <p>45° SSDCN</p>	<p>S Sistem/S System</p> <p>1212 F09 1616 H09-Z 1616 H09 2020 K09-Z 2020 K09 1616 H12-Z 1616 H12 2020 K12 2525 M12</p>	 <p>90° STGCR / L</p> <p>S Sistem/S System</p> <p>0808 E09 1010 E09 1212 F11 1616 H11 2020 K16 2525 M16 3232 P16</p>
 <p>45° SSSCR / L</p>	<p>S Sistem/S System</p> <p>1212 F09 1616 H09-Z 1616 H09 2020 K09-Z 2020 K09</p> <p>1616 H12 2020 K12-Z 2020 K12 2525 M12-Z 2525 M12</p>	 <p>90° STFCR / L</p>	<p>S Sistem/S System</p> <p>0808 E09 1010 E09 1212 F11 1616 H11</p> <p>1616 H16 2020 K16 2525 M16 3232 P16</p>	

Dış Çap Tornalama Katerleri / External Turning Toolholders

 <p>S Sistem/S System</p> <p>0808 E09 1010 E09 1212 F11 1616 H11 1616 H16 2020 K16 2525 M16 3232 P16</p> <p>93° STJCR / L</p>	 <p>S Sistem/S System</p> <p>2020 L11 1616 K16 2020 M16 2525 P16 3232 R16 2525 P22</p> <p>90° STCCN</p>	 <p>S Sistem/S System</p> <p>0808 E09 1010 E09 1212 F11 1616 H11 2020 K16 2525 M16 3232 P16</p> <p>93° STUCR / L</p>
 <p>S Sistem/S System</p> <p>1212 F11 1616 H11 2020 K11 2020 K16 2525 M16 3232 P16</p> <p>107.5° SVHBR / L</p>	 <p>S Sistem/S System</p> <p>1212 F11 1616 H11 2020 K11 2020 K16 2525 M16 3232 P16</p> <p>107.5° SVHCR / L</p>	 <p>S Sistem/S System</p> <p>1212 F11 1616 H11 2020 K11 1616 H16 2020 K16 2525 M16 3232 P16</p> <p>93° SVJBR / L</p>
 <p>S Sistem/S System</p> <p>1212 F11 1616 H11 2020 K11 1212 F16 2020 K16 2525 M16 3232 P16</p> <p>93° SVJCR / L</p>	 <p>S Sistem/S System</p> <p>1212 F11 1616 H11 2020 K11 2020 K16 2525 M16 3232 P16</p> <p>72.5° SVVBN</p>	 <p>S Sistem/S System</p> <p>1212 F11 1616 H11 2020 K11 2020 K16 2525 M16 3232 P16</p> <p>72.5° SVVCN</p>
 <p>S Sistem İsviçre Tipi / S System Swiss Type</p> <p>0808 X06-S 1010 K06-S 1212 G06-S 1212 K06-S</p> <p>90° SCACR / L</p>	 <p>S Sistem İsviçre Tipi / S System Swiss Type</p> <p>1212 K09-S 1616 K09-S 2020 K09-S</p> <p>90° SDACR / L</p>	 <p>S Sistem İsviçre Tipi / S System Swiss Type</p> <p>0808 X07-S 1010 K07-S 1212 K07-S 1616 F07-S 1616 K07-S</p> <p>90° SDACR / L</p>
 <p>S Sistem İsviçre Tipi / S System Swiss Type</p> <p>1216 K11-S 1616 K11-S 1216 K16-S 1616 K16-S</p> <p>91° STGCR / L</p>	 <p>S Sistem İsviçre Tipi / S System Swiss Type</p> <p>0808 X06-S 1010 X06-S 1212 G06-S 1212 X06-S 1212 K06-S 1616 F06-S 1616 X06-S</p> <p>95° SCLCR / L</p>	 <p>S Sistem İsviçre Tipi / S System Swiss Type</p> <p>1212 K11-S 1212 X09-S 1616 F09-S 1616 G09-S 1616 X09-S 2020 X09-S</p> <p>95° SCLCR / L</p>
 <p>S Sistem İsviçre Tipi / S System Swiss Type</p> <p>0808 X07-S 1010 X07-S 1212 G07-S 1212 X07-S 1616 F07-S 1616 X07-S 2020 X07-S</p> <p>93° SDJCR / L</p>	 <p>S Sistem İsviçre Tipi / S System Swiss Type</p> <p>1212 G11-S 1212 X11-S 1212 K11-S 1616 F11-S 1616 X11-S 1616 K11-S 2020 X11-S</p> <p>90° SVACR / L</p>	 <p>S Sistem İsviçre Tipi / S System Swiss Type</p> <p>1010 K11-S 1212 K11-S 1616 K11-S 2020 K11-S 1212 K16-S 1616 K16-S</p> <p>90° SVACR / L</p>



S Sistem İsviçre Tipi / S System Swiss Type

1616 K11-S

93° **SVJBR / L**



S Sistem İsviçre Tipi / S System Swiss Type

0808 X11-S
1212 K11-S

93° **SVJCR / L**



T Sistem/T System

S25S TCLNR/L 09-Z
S25S TCLNR/L 09
S25S TCLNR/L 12-Z
S25S TCLNR/L 12

95° **TCLNR / L**

S32T TCLNR/L 12
S40U TCLNR/L 12
S50V TCLNR/L 12

S32T TCLNR/L 16
S40U TCLNR/L 16
S50V TCLNR/L 16



T Sistem/T System

S32T TD-NR/L 15
S40U TD-NR/L 15
S50V TD-NR/L 15

62.5° **TD-NR / L**



T Sistem/T System

S25S TDQNR/L 11-Z
S25S TDQNR/L 11
S32T TDQNR/L 11
S25S TDQNR/L 15
S32T TDQNR/L 15
S40U TDQNR/L 15
S50V TDQNR/L 15

107.5° **TDQNR / L**



T Sistem/T System

S25S TDUNR/L 11-Z
S25S TDUNR/L 11
S32T TDUNR/L 11
S25S TDUNR/L 15
S32T TDUNR/L 15
S40U TDUNR/L 15
S50V TDUNR/L 15

93° **TDUNR / L**



T Sistem/T System

S25S TSKNR/L 12-Z
S25S TSKNR/L 12
S32T TSKNR/L 12
S40U TSKNR/L 12

75° **TSKNR / L**



T Sistem/T System

S25S TT-NR/L 16-Z
S25S TT-NR/L 16
S32T TT-NR/L 16

60° **TT-NR / L**



T Sistem/T System

S25S TTUNR/L 16-Z
S25S TTUNR/L 16
S32T TTUNR/L 16
S25S TTUNR/L 22
S32T TTUNR/L 22
S40U TTUNR/L 22
S50V TTUNR/L 22

93° **TTUNR / L**



T Sistem/T System

S25S TVUNR/L 16
S32T TVUNR/L 16
S40U TVUNR/L 16

93° **TVUNR / L**



T Sistem/T System

S25S TWLNR/L 06-Z
S25S TWLNR/L 06
S32T TWLNR/L 06
S25S TWLNR/L 08-Z
S25S TWLNR/L 08
S32T TWLNR/L 08
S40U TWLNR/L 08
S50V TWLNR/L 08

95° **TWLNR / L**



C Sistem/C System

S25S CKUNR/L 16
S32T CKUNR/L 16
S40U CKUNR/L 16
S50V CKUNR/L 16

93° **CKUNR / L**



M Sistem/M System

S20R MCLNR/L 12
S25S MCLNR/L 12-Z
S25S MCLNR/L 12
S32T MCLNR/L 12

95° **MCLNR / L**



M Sistem/M System

S20R MDUNR/L 11
S25S MDUNR/L 11
S25S MDUNR/L 15-Z
S25S MDUNR/L 15
S32T MDUNR/L 15
S40U MDUNR/L 15
S50V MDUNR/L 15

93° **MDUNR / L**



M Sistem/M System

S20R MTFNR/L 16
S25S MTFNR/L 16
S32T MTFNR/L 16
S40U MTFNR/L 16
S32T MTFNR/L 22
S40U MTFNR/L 22
S50V MTFNR/L 22

90° **MTFNR / L**



M Sistem/M System

S20R MT-NR/L 16
S25S MT-NR/L 16-Z
S25S MT-NR/L 16
S32T MT-NR/L 16
S40U MT-NR/L 16
S32T MT-NR/L 22
S40U MT-NR/L 22
S50U MT-NR/L 22

60° **MT-NR / L**

Delik İçi Tornalama Katerleri / Boring Bars

 <p>M Sistem/M System</p> <p>S20R MTQNR/L 16 S25S MTQNR/L 16-Z S25S MTQNR/L 16 S32T MTQNR/L 16 S40U MTQNR/L 16 S32T MTQNR/L 22 S40U MTQNR/L 22 S50V MTQNR/L 22</p> <p>107.5° MTQNR / L</p>	 <p>M Sistem/M System</p> <p>S20R MTUNR/L 16 S25S MTUNR/L 16-Z S25S MTUNR/L 16</p> <p>93° MTUNR / L</p> <p>S32T MTUNR/L 16 S40U MTUNR/L 16 S50V MTUNR/L 16</p> <p>S32T MTUNR/L 22 S40U MTUNR/L 22 S50V MTUNR/L 22</p>	
 <p>M Sistem/M System</p> <p>S16P MWLNR/L 06 S20R MWLNR/L 06 S25S MWLNR/L 06 S25S MWLNR/L 08-Z S25S MWLNR/L 08 S32T MWLNR/L 08 S40U MWLNR/L 08</p> <p>95° MWLNR / L</p>	 <p>P Sistem/P System</p> <p>S16P PCLNR/L 09 S20R PCLNR/L 09 S25S PCLNR/L 09 S25S PCLNR/L 12C S32T PCLNR/L 12C S40U PCLNR/L 12C S50V PCLNR/L 12C</p> <p>95° PCLNR / L</p> <p>S32T PCLNR/L 16C S40U PCLNR/L 16C S50V PCLNR/L 16C S40U PCLNR/L 19C S50V PCLNR/L 19C A25R PCLNR/L 12C A32S PCLNR/L 12C</p> <p>A40T PCLNR/L 12C A50U PCLNR/L 12C A32S PCLNR/L 16C A40T PCLNR/L 16C A50U PCLNR/L 16C A40T PCLNR/L 19C A50U PCLNR/L 19C</p>	
 <p>P Sistem/P System</p> <p>S25S PDQNR/L 11 S32T PDQNR/L 1504 A32S PDQNR/L 15 S32T PDQNR/L 15 S40U PDQNR/L 1504 A40T PDQNR/L 15 S40U PDQNR/L 15 S50V PDQNR/L 1504 A50U PDQNR/L 15 S50V PDQNR/L 15 A20P PDQNR/L 11 A32S PDQNR / L 1504 A25R PDQNR/L 11 A40T PDQNR / L 1504</p> <p>107.5° PDQNR / L</p>	 <p>P Sistem/P System</p> <p>S20R PDUNR/L 11 A20P PDUNR/L 11 S25S PDUNR/L 11 A25R PDUNR/L 11 S25S PDUNR/L 15 A32S PDUNR/L 11 S32T PDUNR/L 15 A32S PDUNR/L 15 S40U PDUNR/L 15 A40T PDUNR/L 15 S50V PDUNR/L 15 A50U PDUNR/L 15</p> <p>93° PDUNR / L</p>	
 <p>P Sistem/P System</p> <p>S32T PDXNR/L 15 S40U PDXNR/L 15 S50V PDXNR/L 15</p> <p>93° PDXNR / L</p>	 <p>P Sistem/P System</p> <p>S25S PSKNR/L 12C S32T PSKNR/L 12C S40U PSKNR/L 12C S50V PSKNR/L 12C S40U PSKNR/L 15</p> <p>75° PSKNR / L</p>	 <p>P Sistem/P System</p> <p>S16P PTUNR/L 16 S20R PTUNR/L 16 S25S PTUNR/L 16C S32T PTUNR/L 16C S40U PTUNR/L 16C S32T PTUNR/L 22C S40U PTUNR/L 22C S50V PTUNR/L 22C</p> <p>93° PTUNR / L</p>
 <p>P Sistem/P System</p> <p>S20R PWLNR/L 06 S25S PWLNR/L 08C A20P PWLNR/L 06 S25S PWLNR/L 06 S32T PWLNR/L 08C A25R PWLNR/L 06 S32T PWLNR/L 06 S40U PWLNR/L 08C A32S PWLNR/L 06 S50V PWLNR/L 08C A25R PWLNR/L 08C A32S PWLNR/L 08C A40T PWLNR/L 08C A50U PWLNR/L 08C</p> <p>95° PWLNR / L</p>	 <p>S Sistem/S System</p> <p>S08H SCFCR/L 06 S10K SCFCR/L 06 S12K SCFCR/L 06 S12K SCFCR/L 09 S16P SCFCR/L 09 S20R SCFCR/L 09 S25S SCFCR/L 09-Z S25S SCFCR/L 09</p> <p>90° SCFCR / L</p>	
 <p>S Sistem/S System</p> <p>S0608H SCLCR/L 03 S12K SCLCR/L 09 S32T SCLCR/L 09 S0608H SCLCR/L 06 S1416P SCLCR/L 09 S25S SCLCR/L 12-Z S08H SCLCR/L 06 S16P SCLCR/L 09 S25S SCLCR/L 12 S10K SCLCR/L 06 S1620R SCLCR/L 09 S32T SCLCR/L 12 S12K SCLCR/L 06 S20R SCLCR/L 09 S40U SCLCR/L 12 S1216P SCLCR/L 06 S25S SCLCR/L 09-Z A08H SCLCR/L 06 S16P SCLCR/L 06 S25S SCLCR/L 09 A10H SCLCR/L 06</p> <p>95° SCLCR / L</p> <p>A12H SCLCR/L 06 A16M SCLCR/L 09 A20P SCLCR/L 09 A25R SCLCR/L 09 A32S SCLCR/L 09 A25R SCLCR/L 12</p>		



 <p>S Sistem/S System S10K SD-CR/L 07 S12K SD-CR/L 07 S16P SD-CR/L 07 S20R SD-CR/L 07 S16P SD-CR/L 11 S20R SD-CR/L 11 S25S SD-CR/L 11-Z S25S SD-CR/L 11 S32T SD-CR/L 11 S40U SD-CR/L 11</p> <p>62.5° SD-CR / L</p>	 <p>S Sistem/S System S10K SDPCR/L 07 S12K SDPCR/L 07 S16P SDPCR/L 11 S20R SDPCR/L 11 S25S SDPCR/L 11</p> <p>117.5° SDPCR / L</p>	 <p>S Sistem/S System S16P SRGCR/L 08 S20R SRGCR/L 08 S25S SRGCR/L 08C S32T SRGCR/L 08C S40U SRGCR/L 08C</p> <p>-° SRGCR / L</p>	
 <p>S Sistem/S System S10K SDQCR/L 07 S12K SDQCR/L 07 S16P SDQCR/L 07 S20R SDQCR/L 07</p> <p>107.5° SDQCR / L</p>	<p>S16P SDQCR/L 11 S20R SDQCR/L 11 S25S SDQCR/L 11-Z S25S SDQCR/L 11 S32T SDQCR/L 11 S40U SDQCR/L 11</p>	<p>A10H SDQCR/L 07 A12H SDQCR/L 07 A16M SDQCR/L 07 A20P SDQCR/L 07</p>	<p>A16M SDQCR/L 11 A20P SDQCR/L 11 A25R SDQCR/L 11 A32S SDQCR/L 11</p>
 <p>S Sistem/S System S0810K SDUCR/L 07 S10K SDUCR/L 07 S12K SDUCR/L 07 S1216P SDUCR/L 07 S1416P SDUCR/L 07 S16P SDUCR/L 07 S20R SDUCR/L 07</p> <p>93° SDUCR / L</p>	<p>S1416P SDUCR/L 11 S16P SDUCR/L 11 S1620R SDUCR/L 11 S20R SDUCR/L 11 S25S SDUCR/L 11-Z S25S SDUCR/L 11 S32T SDUCR/L 11</p>	<p>S40U SDUCR/L 11 S50V SDUCR/L 11 A0810H SDUCR/L 07 A10H SDUCR/L 07 A12H SDUCR/L 07 A16M SDUCR/L 07 A20P SDUCR/L 07</p>	<p>A16M SDUCR/L 11 A20P SDUCR/L 11 A25R SDUCR/L 11 A32S SDUCR/L 11</p>
 <p>S Sistem/S System S12K SDXCR/L 07 S16P SDXCR/L 07 S20R SDXCR/L 07 S16P SDXCR/L 11 S20R SDXCR/L 11 S25S SDXCR/L 11-Z S25S SDXCR/L 11 S32T SDXCR/L 11 S40U SDXCR/L 11</p> <p>93° SDXCR / L</p>	 <p>S Sistem/S System S16P SSSCR/L 09 S20R SSSCR/L 09 S25S SSSCR/L 09 S25S SSSCR/L 09-Z S32T SSSCR/L 12 S40U SSSCR/L 12</p> <p>45° SSSCR / L</p>	 <p>S Sistem/S System S12K ST-CR/L 11 S16P ST-CR/L 11 S20R ST-CR/L 11 S16P ST-CR/L 16 S20R ST-CR/L 16 S25S ST-CR/L 16-Z S25S ST-CR/L 16 S32T ST-CR/L 16 S40U ST-CR/L 16</p> <p>60° ST-CR / L</p>	
 <p>S Sistem/S System S0610F STFCR/L 06 S08H STFCR/L 06 S10K STFCR/L 09 S12K STFCR/L 09 S12K STFCR/L 11 S16P STFCR/L 11 S20R STFCR/L 11 S25S STFCR/L 16-Z S25S STFCR/L 16 S32T STFCR/L 16</p> <p>90° STFCR / L</p>	 <p>S Sistem/S System S10K STUCR/L 09 S12K STUCR/L 09 S12K STUCR/L 11 S16P STUCR/L 11 S20R STUCR/L 11 S25S STUCR/L 16-Z S25S STUCR/L 16</p> <p>93° STUCR / L</p>		
 <p>S Sistem/S System S08H STUPR/L 0802 S10K STUPR/L 1103 S12K STUPR/L 1103 S12M STUPR/L 1103 S16P STUPR/L 1103 S16R STUPR/L 1103</p> <p>93° STUPR / L</p>	 <p>S Sistem/S System S25S SVJBR/L 16 S32T SVJBR/L 16 S40U SVJBR/L 16</p> <p>93° SVJBR / L</p>	 <p>S Sistem/S System S12K SVJCR/L 11 S16P SVJCR/L 11 S20R SVJCR/L 11</p> <p>93° SVJCR / L</p>	

Delik İçi Tornalama Katerleri / Boring Bars



S Sistem/S System

S16P SVQBR/L 11
S20R SVQBR/L 11
S25S SVQBR/L 16-Z
S25S SVQBR/L 16
S32T SVQBR/L 16
S40U SVQBR/L 16
A20Q SVQBR/L 11
A20Q SVQBR/L 16
A25S SVQBR/L 16
A32S SVQBR/L 16

107.5° **SVQBR / L**



S Sistem/S System

S16P SVQCR/L 11
S20R SVQCR/L 11
S25S SVQCR/L 16-Z
S25S SVQCR/L 16
S32T SVQCR/L 16
S40U SVQCR/L 16

107.5° **SVQCR / L**



S Sistem/S System

S16P SVUBR/L 11
S20R SVUBR/L 11
S25S SVUBR/L 16-Z
S25S SVUBR/L 16
S32T SVUBR/L 16
S40U SVUBR/L 16
A20Q SVUBR/L 16
A32S SVUBR/L 16

93° **SVUBR / L**



S Sistem/S System

S16P SVUCR/L 11
S20R SVUCR/L 11
S25S SVUCR/L 16-Z
S25S SVUCR/L 16
S32T SVUCR/L 16
S40U SVUCR/L 16

93° **SVUCR / L**



S Sistem/S System

S16P SVXBR/L 1102
S20R SVXBR/L 1102
S16P SVXBR/L 11
S20R SVXBR/L 11
S25S SVXBR/L 16
S32T SVXBR/L 16
S40U SVXBR/L 16

93° **SVXBR / L**



S Sistem/S System

S0608H SWLCR 03
S0810K SWLCR 03

95° **SWLCR**



S Sistem/S System

S08H SWUBR 06-5.5
S08H SWUBR 06-7
S0610H SWUBR 06

93° **SWUBR**



S Sistem Karbür Şaftlı S System Carbide Shank

E08K SCLCR/L 06
E10M SCLCR/L 06
E12Q SCLCR/L 06
E16R SCLCR/L 09
E20S SCLCR/L 09

95° **SCLCR / L**



S Sistem Karbür Şaftlı S System Carbide Shank

E10M SDUCR/L 07
E12Q SDUCR/L 07
E16R SDUCR/L 11
E20S SDUCR/L 11

93° **SDUCR / L**

S-Sistem Delik İçi Tornalama Kater Setleri / S-System Boring Bars Sets



S Sistem/S System

A08H SCLCR/L 06
A10H SCLCR/L 06
A12H SCLCR/L 06
A16M SCLCR/L 09

95° **SET-A/SCLCR/L**



S Sistem/S System

E08K SCLCR/L 06
E10M SCLCR/L 06
E12Q SCLCR/L 06
E16R SCLCR/L 09

95° **SET-E/SCLCR/L**



S Sistem/S System

S08H SCLCR/L 06
S10K SCLCR/L 06
S12K SCLCR/L 06
S16P SCLCR/L 09

95° **SET-S/SCLCR/L**



S Sistem/S System

A10H SDUCR/L 07
A12H SDUCR/L 07
A16M SDUCR/L 11

93° **SET-A/SDUCR/L**



S Sistem/S System

E10M SDUCR/L 07
E12Q SDUCR/L 07
E16R SDUCR/L 11

93° **SET-E/SDUCR/L**



S Sistem/S System

S10K SDUCR/L 07
S12K SDUCR/L 07
S16P SDUCR/L 11

93° **SET-S/SDUCR/L**

Kartuşlar / Cartridge



S Sistem/S System

S10X SCACR/L 06
S10A SCACR/L 06
S1018 SCACR/L 06
S1065 SCACR/L 06
S10C SCACR/L 06
S12B SCACR/L 06
S12D SCACR/L 06
S12D SCACR/L 09

90° **SCACR / L**

S1265 SCACR/L 09
S12H SCACR/L 09
S15C SCACR/L 09
S1554 SCACR/L 09
S15E SCACR/L 09
S15D SCACR/L 09
S16A SCACR/L 09
S16B SCACR/L 09

S16C SCACR/L 09
S16D SCACR/L 09
S16E SCACR/L 09
S16G SCACR/L 09
S16H SCACR/L 09
S1868 SCACR/L 09
S18E SCACR/L 09
S1888 SCACR/L 09

S18105 SCACR/L 09
S18175 SCACR/L 09
S20E SCACR/L 09
S20E SCACR/L 12
S20H SCACR/L 12



Kartuşlar / Cartridge

 <p>50° SCMCN</p>	<p>S Sistem/S System</p> <p>S10X SCMCN 06 S12D SCMCN 06 S16C SCMCN 09 S16D SCMCN 09</p>	 <p>-° STXCR / L</p>	<p>S Sistem/S System</p> <p>STXCR/L 2020 B16 STXCR/L 2020 E16 STXCR/L 2020 B16-SA STXCR/L 2020 E16-SA STXCR/L 2020 B16-PL STXCR/L 2020 E16-PL STXCR/L 2020 H16-PL</p>	 <p>90° CTFPR / L</p>	<p>C Sistem/C System</p> <p>13CS 16 15CS 22</p>
 <p>45° CTSPR / L</p>	<p>C Sistem/C System</p> <p>11.5CS 11</p>	 <p>95° MSYNR / L</p>	<p>M Sistem/M System</p> <p>11.5CS 12 16CS 12</p>	 <p>90° SCFCR / L</p>	<p>S Sistem/S System</p> <p>06CA 06 08CA 06 10CA 09 12CA 12 16CA 12</p>
 <p>45° SCSCR / L</p>	<p>S Sistem/S System</p> <p>06CA 06 10CA 09 12CA 12</p>	 <p>75° SSKCR / L</p>	<p>S Sistem/S System</p> <p>10CA 09</p>	 <p>90° STFCR / L</p>	<p>S Sistem/S System</p> <p>08CA 09 10CA 11 12CA 16 16CA 16</p>
 <p>45° STSCR / L</p>	<p>S Sistem/S System</p> <p>08CA 09 10CA 11 12CA 16</p>	 <p>60° STTCR / L</p>	<p>S Sistem/S System</p> <p>08CA 09 10CA 11</p>	 <p>75° PSKNR / L</p>	<p>P Sistem/P System</p> <p>16CA 12</p>
 <p>90° PTFNR / L</p>	<p>P Sistem/P System</p> <p>12CA 16 16CA 16</p>	 <p>45° PSDNN</p>	<p>P Sistem/P System</p> <p>S22D PSDNN 12C</p>	 <p>75° PSRNR / L</p>	<p>P Sistem/P System</p> <p>16CA 12</p>

Boru Pahlama Takımları / Pipe Beveling and Chamfering Tools



Takım Kodu Tool Code	Dmax		Dmin		Max (Dout-Din)
	D in	D out	D in	D out	
ACPBT-1	27-52	52	18-36	36	27
ACPBT-2	27-49	52	25-36	36	27
ACPBT-3	48-75	75	41	42	27
ACPBT-4	51-75	75	51	52	27
ACPBT-5	22-35	35	22	23	27
ACPBT-6	15-35	35	15	16	27
ACPBT-7	49-53	75	32-36	36	27
ACPBT-8	49	75	33-37	37	27



Takım Kodu Tool Code	D1		D2	
	Dmax	Dmin	Dmax	Dmin
ACPBT-9	38	24	15	1
ACPBT-10	78	64	43	29

Boru Pahlama Takımı Kartuşları / Pipe Beveling and Chamfering Tool Cartridges

Takım Adı/Tool Code		Dış Çap ve Delik İçi Dış Açma Takımları / External and Internal Threading Toolholders							
	ÖTG-TC11-4IL ÖTG-TC11-4IR ÖTG-TC16-1AL ÖTG-TC16-1AR ÖTG-TC16-2DL ÖTG-TC16-2DR ÖTG-TC16-3IL ÖTG-TC16-3IR				Dış Çap Dış Açma İsviçre Tipi Kayar Otomat Makina Katerleri External Threading Toolholders For Swiss Type Sliding Automatic Lathes 1010 K11-S 1212 K11-S				
	°	ÖTG-TC..	SER / L						
	Dış Çap Dış Açma/External Threading Toolholders				Dış Çap Dış Açma/External Threading Toolholders				
	0808 E11 2525 M16C 2525 M16C-T 1010 E11 3232 P16C 2525 M22C-T 1212 F 11 2525 M22C 2020 K16C-S 1616 H11 3232 P22C 2525 M16C-S 1616 H16C 4040 S22C 3232 P16C-S 2020 K16C	1616 H16 2525 M22 2525 M27 2020 K16 3232 P22 3232 P27 2525 M16 4040 S22 4040 S27 3232 P16							
SER / L					TER / L				
	Delik İçi Dış Açma Takımları/Internal Threading Toolholders				Delik İçi Dış Açma Takımları/Internal Threading Toolholders				
	S12X05H 06 S16M 16 S25R 22C S16X07M 08 S20x16P 16 S32S 22C S10H 11 S20P 16 S40T 22C S12K 11 S25R 16C S50U 22C S16X10M 11 S32S 16C S25R 16C-T S16X13M 11 S40T 16C S32S 16C-T S16M 11 S50U 16C S25R 22C-T S16x13M 16 S20P 22 S32S 22C-T	S25R 16 S25R 22 S32S 27 S32S 16 S32S 22 S40T 27 S40T 16 S40T 22 S50U 27 S50U 16 S50U 22							
SIR / L					TIR / L				

Kanal Açma Takımları / Grooving Toolholders

Dış Çap Kanal Açma Takımları / External Grooving Toolholders

	ADKT-K-R/L-1212-2-T15 ADKT-K-R/L-2020-3-R28 ADKT-K-R/L-3232-4-T22 ADKT-K-R/L-1616-2-T15 ADKT-K-R/L-2525-3-R15 ADKT-K-R/L-2020-5-T20 ADKT-K-R/L-2020-2-T15 ADKT-K-R/L-2525-3-T22 ADKT-K-R/L-2525-5-T18 ADKT-K-R/L-2525-2-T15 ADKT-K-R/L-3232-3-T22 ADKT-K-R/L-2525-5-T25 ADKT-K-R/L-3232-2-T15 ADKT-K-R/L-2020-4-T20 ADKT-K-R/L-3232-5-T25 ADKT-K-R/L-1212-3-T15 ADKT-K-R/L-2020-4-R25 ADKT-K-R/L-2525-6-T25 ADKT-K-R/L-1616-3-T15 ADKT-K-R/L-2525-4-T18 ADKT-K-R/L-3232-6-T25 ADKT-K-R/L-2020-3-T20 ADKT-K-R/L-2525-4-T22 ADKT-K-R/L-3232-8-T32		ADKT-KG-R/L-2020-2-T15 ADKT-KG-R/L-2525-2-T15 ADKT-KG-R/L-2525-2-T17 ADKT-KG-R/L-1616-3-T20 ADKT-KG-R/L-2020-3-T20 ADKT-KG-R/L-2525-3-T22 ADKT-KG-R/L-2020-4-T20 ADKT-KG-R/L-2525-4-T16 ADKT-KG-R/L-2525-4-T22 ADKT-KG-R/L-2525-5-T25 ADKT-KG-R/L-2525-6-T25
	KRLY - JD (MGM.) UCUNA UYGUNDUR COMPATIBLE WITH KRLY - JD (MGM.) INSERT		KRLY (KG.) UCUNA UYGUNDUR COMPATIBLE WITH KRLY (KG.) INSERT
	ADKT-H-R/L-2020-3-T20 ADKT-H-R/L-2525-3-T22 ADKT-H-R/L-2525-3-T26 ADKT-H-R/L-2020-4-T20 ADKT-H-R/L-2525-4-T22 ADKT-H-R/L-3232-4-T22 ADKT-H-R/L-2020-5-T20 ADKT-H-R/L-2525-5-T25 ADKT-H-R/L-2525-6-T25		ADKT-HK-R/L-1616-2-T15 ADKT-HK-R/L-2020-2-T15 ADKT-HK-R/L-2525-2-T15 ADKT-HK-R/L-2020-3-T20 ADKT-HK-R/L-2525-3-T22 ADKT-HK-R/L-2020-4-T20 ADKT-HK-R/L-2525-4-T22 ADKT-HS223-R/L-2020-2-T15 ADKT-HS223-R/L-2020-3-T17
	HRN (S229) UCUNA UYGUNDUR COMPATIBLE WITH HRN (S229) INSERT		HRN (S224-S223) UCUNA UYGUNDUR COMPATIBLE WITH HRN (S224-S223) INSERT
HRN (S229) UCUNA UYGUNDUR COMPATIBLE WITH HRN (S229) INSERT		ZCC (ZQMX) UCUNA UYGUNDUR COMPATIBLE WITH ZCC (ZQMX) INSERT	



ZCC (Z..D) UCUNA UYGUNDUR
COMPATIBLE WITH ZCC (Z..D) INSERT

ADKT-ZCC2-R/L-1616-2-T15
ADKT-ZCC2-R/L-2020-2-T15
ADKT-ZCC2-R/L-2525-2-T15
ADKT-ZCC2-R/L-1616-2.5-T15
ADKT-ZCC2-R/L-2020-2.5-T17
ADKT-ZCC2-R/L-2525-2.5-T15
ADKT-ZCC2-R/L-1616-3-T15
ADKT-ZCC2-R/L-1616-3-T17
ADKT-ZCC2-R/L-1616-3-T20
ADKT-ZCC2-R/L-2020-3-T12

ADKT-ZCC2-R/L-2020-3-T20
ADKT-ZCC2-R/L-2020-3-R21
ADKT-ZCC2-R/L-2020-3-R25
ADKT-ZCC2-R/L-2525-3-T12
ADKT-ZCC2-R/L-2525-3-T22
ADKT-ZCC2-R/L-2525-3-R30
ADKT-ZCC2-R/L-2020-4-T12
ADKT-ZCC2-R/L-2020-4-T20
ADKT-ZCC2-R/L-2525-4-T12
ADKT-ZCC2-R/L-2525-4-T22

ADKT-ZCC2-R/L-2020-5-T12
ADKT-ZCC2-R/L-2020-5-T20
ADKT-ZCC2-R/L-2525-5-T12
ADKT-ZCC2-R/L-2525-5-T25
ADKT-ZCC2-R/L-3232-5-T25
ADKT-ZCC2-R/L-2020-6-T20
ADKT-ZCC2-R/L-2525-6-T25
ADKT-ZCC2-R/L-3232-6-T25
ADKT-ZCC2-R/L-3232-6-T30



KNMTL (A4.) UCUNA UYGUNDUR
COMPATIBLE WITH KNMTL (A4.) INSERT

ADKT-KM-R/L-2020-2-T15
ADKT-KM-R/L-2525-2-T15
ADKT-KM-R/L-2020-3-T20
ADKT-KM-R/L-2525-3-T22
ADKT-KM-R/L-2525-4-T22



ISCR (DGN-GRP-GIM-GIP-GTN-DCE) UCUNA UYGUNDUR
COMPATIBLE WITH ISCR (DGN-GRP-GIM-GIP-GTN-DCE) INSERT

ADKT-I-R/L-1212-2-T15
ADKT-I-R/L-1616-2-T15
ADKT-I-R/L-2020-2-T15
ADKT-I-R/L-2525-2-T15
ADKT-I-R/L-3232-2-T15
ADKT-I-R/L-1212-3-T15
ADKT-I-R/L-1616-3-T15
ADKT-I-R/L-2020-3-T20
ADKT-I-R/L-2525-3-T22

ADKT-I-R/L-3232-3-T22
ADKT-I-R/L-2020-4-T20
ADKT-I-R/L-2525-4-T22
ADKT-I-R/L-3232-4-T25
ADKT-I-R/L-2020-5-T20
ADKT-I-R/L-2525-5-T25
ADKT-IG-R/L-1616-3-T18
ADKT-IG-R/L-2020-3-R20
ADKT-IG-R/L-2525-3-T22

ADKT-IGI-R/L-2020-2-T15
ADKT-IGI-R/L-2525-2-T15
ADKT-IGI-R/L-1616-3-T15
ADKT-IGI-R/L-2020-3-T20
ADKT-IGI-R/L-2525-3-T22
ADKT-IGI-R/L-2525-4-T22
ADKT-IGI-R/L-2525-5-T25
ADKT-IGI-R/L-2525-8-T30
ADKT-IGTN-R/L-2525-5-T25
ADKT-IDC-R/L-2525-3-T21



ISCR (TGM.) UCUNA UYGUNDUR
COMPATIBLE WITH ISCR (TGM.) INSERT

ADKT-ITG-R/L-2020-3-T8
ADKT-ITG-R/L-2525-3-T8
ADKT-ITG-R/L-3232-3-T8
ADKT-ITG-R/L-2020-4-T9
ADKT-ITG-R/L-2525-4-T17
ADKT-ITG-R/L-3232-4-T17
ADKT-ITG-R/L-3232-5-T25



SNDVK (123) UCUNA UYGUNDUR
COMPATIBLE WITH SNDVK (123) INSERT

ADKT-123-R/L-1212-1.5-R15
ADKT-123-R/L-1616-1.5-R15
ADKT-123-R/L-1616-2-T15
ADKT-123-R/L-2020-2-T8
ADKT-123-R/L-2020-2-T15
ADKT-123-R/L-2525-2-T15
ADKT-123-R/L-3232-2-T15
ADKT-123-R/L-1616-3-T15

ADKT-123-R/L-2020-3-T20
ADKT-123-R/L-2525-3-T22
ADKT-123-R/L-2020-4-T20
ADKT-123-R/L-2525-4-T22
ADKT-123-R/L-3232-4-T25
ADKT-123-R/L-2020-5-T20
ADKT-123-R/L-2525-5-T25
ADKT-123-R/L-3232-6-T15



SNDVK (151.2) UCUNA UYGUNDUR
COMPATIBLE WITH SNDVK (151.2) INSERT

ADKT-151.22-R/L-1616-2-T15
ADKT-151.22-R/L-2020-2-T15
ADKT-151.22-R/L-2525-2-T15
ADKT-151.22-R/L-1616-3-T15
ADKT-151.22-R/L-2020-3-T20
ADKT-151.22-R/L-2525-3-T22
ADKT-151.22-R/L-1616-4-T15
ADKT-151.22-R/L-2020-4-T20
ADKT-151.22-R/L-2525-4-T22
ADKT-151.22-R/L-2020-5-T20
ADKT-151.22-R/L-2525-5-T25



SNDVK (151.2) UCUNA UYGUNDUR
COMPATIBLE WITH SNDVK (151.2) INSERT

ADKT-151.23-R/L-1616-2-T15
ADKT-151.23-R/L-2020-2-T15
ADKT-151.23-R/L-2525-2-T15
ADKT-151.23-R/L-1616-2.5-T15
ADKT-151.23-R/L-2020-2.5-T15
ADKT-151.23-R/L-2525-2.5-T15
ADKT-151.23-R/L-1212-3-T15
ADKT-151.23-R/L-1616-3-T15

ADKT-151.23-R/L-2020-3-T20
ADKT-151.23-R/L-2525-3-T20
ADKT-151.23-R/L-2525-3-T22
ADKT-151.23-R/L-1616-4-T15
ADKT-151.23-R/L-2020-4-T20
ADKT-151.23-R/L-2525-4-T22
ADKT-151.23-R/L-2020-5-T20
ADKT-151.23-R/L-2525-5-T25



SNDVK (154.91) UCUNA UYGUNDUR
COMPATIBLE WITH SNDVK (154.91) INSERT

ADKT-154-91-R/L-2020-3-T4
ADKT-154-91-R/L-2525-3-T4
ADKT-154-91-R/L-2020-5-T5
ADKT-154-91-R/L-2525-5-T5



ARN (LOMR.) UCUNA UYGUNDUR
COMPATIBLE WITH ARN (LOMR.) INSERT

ADKT-ARN-R/L-2020-2-T15
ADKT-ARN-R/L-2525-2-T15
ADKT-ARN-R/L-2020-3-T20
ADKT-ARN-R/L-2525-3-T22



TGTC (TD.) UCUNA UYGUNDUR
COMPATIBLE WITH TGTC (TD.) INSERT

ADKT-TD-R/L-1212-2-T15
ADKT-TD-R/L-1616-2-T15
ADKT-TD-R/L-2020-2-T9
ADKT-TD-R/L-2020-2-T15
ADKT-TD-R/L-2020-2-T20
ADKT-TD-R/L-2525-2-T17
ADKT-TD-R/L-1212-3-T15
ADKT-TD-R/L-1616-3-T15

ADKT-TD-R/L-2020-3-T20
ADKT-TD-R/L-2020-3-T30
ADKT-TD-R/L-2525-3-T9
ADKT-TD-R/L-2525-3-T22
ADKT-TD-R/L-2525-3-T25
ADKT-TD-R/L-2525-3-T30
ADKT-TD-R/L-2525-4-T22
ADKT-TD-R/L-2525-4-T30



SMTM (wCF.) UCUNA UYGUNDUR
COMPATIBLE WITH SMTM (wCF.) INSERT

ADKT-SWC-R/L-2020-2-T25
ADKT-SWC-R/L-2020-3-T25



SMTM (GCM) UCUNA UYGUNDUR
COMPATIBLE WITH SMTM (GCM) INSERT

ADKT-SGC-R/L-1212-2-R15
ADKT-SGC-R/L-1616-2-R15
ADKT-SGC-R/L-2020-2-R20
ADKT-SGC-R/L-2525-2-R20
ADKT-SGC-R/L-1212-3-R15
ADKT-SGC-R/L-1616-3-R15
ADKT-SGC-R/L-2020-3-R22
ADKT-SGC-R/L-2525-3-R15
ADKT-SGC-R/L-2525-3-R22
ADKT-SGC-R/L-2525-4-R25



HRN (S312) UCUNA UYGUNDUR
COMPATIBLE WITH HRN (S312) INSERT

ADKT-H22-R/L-1616-(0.5-2)-T6
ADKT-H22-R/L-2020-(0.5-2)-T6
ADKT-H22-R/L-2525-(0.5-2)-T6

Kanal Açma Takımları / Grooving Toolholders

 <p>WLTR (GX16-GX24) UCUNA UYGUNDUR COMPATIBLE WITH WLTR (GX16-GX24) INSERT</p>	<p>ADKT-WGX16-R/L-2020-2-R16 ADKT-WGX16-R/L-2525-2-R16 ADKT-WGX24-R/L-2020-3-T20 ADKT-WGX24-R/L-2525-3-T22 ADKT-WGX24-R/L-3232-3-T22 ADKT-WGX24-R/L-2525-4-T22 ADKT-WGX24-R/L-2525-5-T25 ADKT-WGX24-R/L-3232-5-T25</p>	 <p>PLBT (GP) UCUNA UYGUNDUR COMPATIBLE WITH PLBT (GP) INSERT</p>	<p>ADKT-GP-R/L-2020-2-T15 ADKT-GP-R/L-2525-2-T15 ADKT-GP-R/L-2020-3-T20 ADKT-GP-R/L-2525-3-T22 ADKT-GP-R/L-2525-4-T22 ADKT-GP-R/L-2525-5-T25</p>	 <p>ADKT-CD-R/L-2020-3-R20 ADKT-CD-R/L-2525-3-R23</p> <p>CRTZT (GX24.) UCUNA UYGUNDUR COMPATIBLE WITH CRTZT (GX24.) INSERT</p>
<p>Dış Çap Kanal Açma İsviçre Tipi Kayar Otomat Takımları <i>External Grooving Toolholders For Swiss Type Sliding Automatic Lathes</i></p>				
 <p>LMNA (GCTX) UCUNA UYGUNDUR COMPATIBLE WITH LMNA (GCTX) INSERT</p>	<p>ADKT-LGC-R/L-1616-2-D40 ADKT-LGC-R/L-2020-2-D40 ADKT-LGC-R/L-2525-2-D40 ADKT-LGC-R/L-1616-3-T20 ADKT-LGC-R/L-2020-3-T20 ADKT-LGC-R/L-2525-3-T20</p>	 <p>TGTC (TD.) UCUNA UYGUNDUR COMPATIBLE WITH TGTC (TD.) INSERT</p>	<p>ADKT-TD-R/L-1212-2-T12-K-S ADKT-TD-R/L-1616-2-T16-K-S ADKT-TD-R/L-1212-3-T12-K-S ADKT-TD-R/L-1616-3-T16-K-S</p>	
 <p>ZCC (Z..D) UCUNA UYGUNDUR COMPATIBLE WITH ZCC (Z..D) INSERT</p>	<p>ADKT-ZCC2-R/L-1010-2-T12-K-S ADKT-ZCC2-R/L-1212-2-T12-K-S ADKT-ZCC2-R/L-1616-2-R16-K-S ADKT-ZCC2-R/L-1212-3-T12-K-S</p>	 <p>KRLY (KG.) UCUNA UYGUNDUR COMPATIBLE WITH KRLY (KG.) INSERT</p>	<p>ADKT-KG-R/L-1212-2-R12-K-S ADKT-KG-R/L-1616-2-R16-K-S ADKT-KG-R/L-1212-3-R12-K-S ADKT-KG-R/L-1616-3-R16-K-S</p>	
 <p>ISCR (DGN) UCUNA UYGUNDUR COMPATIBLE WITH ISCR (DGN) INSERT</p>	<p>ADKT-I-R/L-0808-2-R10-S ADKT-I-R/L-1010-2-R10-K-S ADKT-I-R/L-1212-2-R12-K-S ADKT-I-R/L-1616-3-R16-S</p>	 <p>WLTR (GX16-GX24) UCUNA UYGUNDUR COMPATIBLE WITH WLTR (GX16-GX24) INSERT</p>	<p>ADKT-WGX16-R/L-1212-2-R12-K-S ADKT-WGX24-R/L-1616-3-R16-K-S</p>	

Dış Çap Alın Kanal Açma Takımları / Face Grooving Toolholders

 <p>KRLY - JD (MGM.) UCUNA UYGUNDUR COMPATIBLE WITH KRLY - JD (MGM.) INSERT</p>	<p>AAKT-K-R/L-2525-34-45-3-T17 AAKT-K-R/L-2525-39-55-3-T17 AAKT-K-R/L-2525-49-80-3-T17 AAKT-K-R/L-2525-70-110-3-T17 AAKT-K-R/L-2525-100-150-3-T17 AAKT-K-R/L-2525-80-180-3-T32 AAKT-K-R/L-2525-175-215-3-T22 AAKT-K-R/L-2525-700-800-3-T17 AAKT-K-R/L-2525-50-85-4-T22</p>	<p>AAKT-K-R/L-2525-70-110-4-T22 AAKT-K-R/L-2525-100-150-4-T22 AAKT-K-R/L-2525-80-180-4-T32 AAKT-K-R/L-2525-180-800-4-T32 AAKT-K-R/L-2525-70-110-5-T25 AAKT-K-R/L-2525-100-150-5-T25 AAKT-K-R/L-2525-80-180-5-T32 AAKT-K-R/L-2525-140-200-5-T25 AAKT-K-R/L-2525-180-800-5-T32</p>	<p>AAKT-K-R/L-2525-60-100-6-T25 AAKT-K-R/L-2525-60-100-6-T35 AAKT-K-R/L-2525-100-200-6-T25 AAKT-K-R/L-2525-100-200-6-T35 AAKT-K-R/L-2525-140-300-6-T35 AAKT-K-R/L-2525-140-300-8-T35 AAKT-K-R/L-3232-140-350-8-T35</p>
---	--	--	--



AAKT-ZCC2-R/L-2525-140-180-2-T4
AAKT-ZCC2-R/L-2525-35-45-3-T17
AAKT-ZCC2-R/L-2525-39-55-3-T17
AAKT-ZCC2-R/L-2525-49-80-3-T17
AAKT-ZCC2-R/L-2525-70-110-3-T17
AAKT-ZCC2-R/L-2525-100-150-3-T17

AAKT-ZCC2-R/L-2525-40-60-4-T22
AAKT-ZCC2-R/L-2525-52-80-4-T22
AAKT-ZCC2-R/L-2525-72-110-4-T22
AAKT-ZCC2-R/L-2525-100-150-4-T22
AAKT-ZCC2-R/L-2525-140-200-4-T22
AAKT-ZCC2-R/L-2525-55-95-5-T25

AAKT-ZCC2-R/L-2525-85-140-5-T25
AAKT-ZCC2-R/L-2525-130-200-5-T25
AAKT-ZCC2-R/L-2525-190-400-5-T25
AAKT-ZCC2-R/L-2525-190-400-5-T35
AAKT-ZCC2-R/L-2525-200-500-5-T17
AAKT-ZCC2-R/L-2525-60-110-6-T15

ZCC (Z..D) UCUNA UYGUNDUR
COMPATIBLE WITH ZCC (Z..D) INSERT



AAKT-IG-R/L-2525-40-60-4-T25
AAKT-IG-R/L-2525-52-80-4-T25
AAKT-IG-R/L-2525-70-110-4-T28
AAKT-IG-R/L-2525-110-200-4-T28
AAKT-IG-R/L-2525-110-200-4-T32
AAKT-IG-R/L-2525-180-800-4-T28
AAKT-IG-R/L-2525-70-110-5-T32
AAKT-IG-R/L-2525-110-200-5-T32
AAKT-IG-R/L-2525-180-800-5-T32
AAKT-IG-R/L-2525-58-100-6-T32
AAKT-IG-R/L-2525-88-180-6-T32

ISCR (DGN-GRP) UCUNA UYGUNDUR
COMPATIBLE WITH ISCR (DGN-GRP) INSERT

L Tip Alın Kanal Açma Takımları/L Type Face External Grooving Toolholders



ALKT-ZCC2-R/L-2525-35-45-3-T10
ALKT-ZCC2-R/L-2525-39-55-3-T10
ALKT-ZCC2-R/L-2525-35- \varnothing -3-T4
ALKT-ZCC2-R/L-2525-40-60-4-T14
ALKT-ZCC2-R/L-2525-52-80-4-T14
ALKT-ZCC2-R/L-2525-72-110-4-T14
ALKT-ZCC2-R/L-2525-100-230-4-T14
ALKT-ZCC2-R/L-2525-40- \varnothing -4-T4

ZCC (Z..D) UCUNA UYGUNDUR
COMPATIBLE WITH ZCC (Z..D) INSERT

**Kesme ve Derin Kanal Açma Lamaları
Blades For Parting and Deep Grooving**



AKL-I-26-2
AKL-I-32-2
AKL-I-26-3
AKL-I-32-3
AKL-I-26-4
AKL-I-32-4

ISCR (DGN-GRP) UCUNA UYGUNDUR
COMPATIBLE WITH ISCR (DGN-GRP) INSERT



AKL-123-32-2
AKL-123-32-3
AKL-123-32-4

SNDVK (123) UCUNA UYGUNDUR
COMPATIBLE WITH SNDVK (123) INSERT



AKL-TD-32-2
AKL-TD-32-3

TGTC (TD.) UCUNA UYGUNDUR
COMPATIBLE WITH TGTC (TD.) INSERT

**Kesme ve Derin Kanal Açma Lama Bloğu
Blocks For Parting and Deep Grooving Blades**



ALBU

ALBU-20-26
ALBU-20-32
ALBU-25-26
ALBU-25-32
ALBU-32-32

Mini Kanal Kateri / Mini Grooving Tool



SNDVK (MB) UCUNA UYGUNDUR
COMPATIBLE WITH SNDVK (MB) INSERT

AIKT-MB07-A16-090-15
AIKT-MB07-A16-090-22
AIKT-MB09-A16-090-19
AIKT-MB09-A16-110-40
AIKT-MB09-A16-095-28

Delik İçi Kanal Açma Takımları / Internal Grooving Toolholders



KRLY - JD (MGM.) UCUNA UYGUNDUR
COMPATIBLE WITH KRLY - JD (MGM.) INSERT

AIKT-K-R/L-16-2-T4
AIKT-K-R/L-20-2-T4
AIKT-K-R/L-25-2-T6
AIKT-K-R/L-20-3-T6
AIKT-K-R/L-20-3-T7
AIKT-K-R/L-25-3-T6
AIKT-K-R/L-25-3-T10
AIKT-K-R/L-32-3-T6

AIKT-K-R/L-32-3-T12
AIKT-K-R/L-40-3-T6
AIKT-K-R/L-40-3-T12
AIKT-K-R/L-20-4-T6
AIKT-K-R/L-20-4-T7
AIKT-K-R/L-25-4-T6
AIKT-K-R/L-25-4-T10
AIKT-K-R/L-32-4-T6

AIKT-K-R/L-32-4-T12
AIKT-K-R/L-40-4-T6
AIKT-K-R/L-40-4-T12
AIKT-K-R/L-25-5-T7
AIKT-K-R/L-32-5-T7
AIKT-K-R/L-40-5-T7
AIKT-K-R/L-40-5-T12



KRLY (KG.) UCUNA UYGUNDUR
COMPATIBLE WITH KRLY (KG.) INSERT

AIKT-KG-R/L-25-2-T7
AIKT-KG-R/L-20-3-T6.5-H
AIKT-KG-R/L-25-3-T7
AIKT-KG-R/L-40-3-T8
AIKT-KG-R/L-25-4-T8

Kanal Açma Takımları / Grooving Toolholders



AIKT-H-R/L-25-3-T8
AIKT-H-R/L-32-3-T7
AIKT-H-R/L-40-3-T7
AIKT-H-R/L-25-4-T8

AIKT-H-R/L-32-4-T7
AIKT-H-R/L-40-4-T7
AIKT-H-R/L-25-5-T8
AIKT-H-R/L-32-5-T7
AIKT-H-R/L-40-5-T7

HRN (S229) UCUNA UYGUNDUR
COMPATIBLE WITH HRN (S229) INSERT



AIKT-154.91-R/L-16-3-T3
AIKT-154.91-R/L-20-3-T4
AIKT-154.91-R/L-25-3-T4
AIKT-154.91-R/L-25-5-T5
AIKT-154.91-R/L-32-5-T5

SNDVK (154.91) UCUNA UYGUNDUR
COMPATIBLE WITH SNDVK (154.91) INSERT



AIKT-123-R/L-20-2-T6
AIKT-123-R/L-25-2-T6
AIKT-123-R/L-32-2-T7
AIKT-123-R/L-20-3-T6
AIKT-123-R/L-25-3-T7
AIKT-123-R/L-32-3-T9

AIKT-123-R/L-20-4-T8
AIKT-123-R/L-25-4-T7
AIKT-123-R/L-32-4-T7
AIKT-123-R/L-32-4-T10
AIKT-123-R/L-25-5-T8
AIKT-123-R/L-32-5-T11

SNDVK (123) UCUNA UYGUNDUR
COMPATIBLE WITH SNDVK (123) INSERT



AIKT-HK-R/L-20-2-T6
AIKT-HK-R/L-25-2-T6
AIKT-HK-R/L-20-3-T6
AIKT-HK-R/L-25-3-T6
AIKT-HK-R/L-32-3-T6
AIKT-HK-R/L-20-4-T6
AIKT-HK-R/L-25-4-T6
AIKT-HK-R/L-32-4-T6

AIKT-HS223-R/L-20-2-T5
AIKT-HS223-R/L-25-2-T5
AIKT-HS223-R/L-20-3-T6
AIKT-HS223-R/L-25-3-T6

HRN (S224-S223) UCUNA UYGUNDUR
COMPATIBLE WITH HRN (S224-S223) INSERT



AIKT-ZCC2-R/L-16-2-T4
AIKT-ZCC2-R/L-20-3-T5
AIKT-ZCC2-R/L-20-3-T8
AIKT-ZCC2-R/L-25-3-T5
AIKT-ZCC2-R/L-25-3-T10
AIKT-ZCC2-R/L-32-3-T6
AIKT-ZCC2-R/L-32-3-T8
AIKT-ZCC2-R/L-32-3-T13
AIKT-ZCC2-R/L-40-3-T12

AIKT-ZCC2-R/L-25-4-T6
AIKT-ZCC2-R/L-32-4-T7
AIKT-ZCC2-R/L-32-4-T8
AIKT-ZCC2-R/L-32-4-T10
AIKT-ZCC2-R/L-32-5-T7
AIKT-ZCC2-R/L-32-5-T8
AIKT-ZCC2-R/L-40-5-T8
AIKT-ZCC2-R/L-40-5-T10

ZCC (Z.D) UCUNA UYGUNDUR
COMPATIBLE WITH ZCC (Z.D) INSERT



AIKT-I-R/L-20-3-T5
AIKT-I-R/L-25-3-T6

ISCR (DGN) UCUNA UYGUNDUR
COMPATIBLE WITH ISCR (DGN) INSERT



AIKT-IG-R/L-25-4-T10-H
AIKT-IG-R/L-32-4-T10-H
AIKT-IG-R/L-40-4-T12-H
AIKT-IG-R/L-25-5-T10-H
AIKT-IG-R/L-32-5-T10-H
AIKT-IG-R/L-40-5-T12-H
AIKT-IG-R/L-50-5-T12-H

ISCR (DGN-GRP) UCUNA UYGUNDUR
COMPATIBLE WITH ISCR (DGN-GRP) INSERT



AIKT-ITG-R/L-16-3-T6-H
AIKT-ITG-R/L-20-3-T6-H
AIKT-ITG-R/L-25-3-T8-H
AIKT-ITG-R/L-32-3-T8-H
AIKT-ITG-R/L-20-4-T6-H
AIKT-ITG-R/L-25-4-T7-H
AIKT-ITG-R/L-25-4-T9-H
AIKT-ITG-R/L-32-4-T11-H
AIKT-ITG-R/L-40-4-T11-H
AIKT-ITG-R/L-32-6.35-T17.5-H

ISCR (TGM) UCUNA UYGUNDUR
COMPATIBLE WITH ISCR (TGM) INSERT



AIKT-IGI-R/L-20-3-T4
AIKT-IGI-R/L-25-3-T5
AIKT-IGI-R/L-32-3-T5
AIKT-IGI-R/L-40-3-T5
AIKT-IGI-R/L-25-5-T10
AIKT-IGI-R/L-25-5-T15

ISCR (GIMI-GPI) UCUNA UYGUNDUR
COMPATIBLE WITH ISCR (GIMI-GPI) INSERT



AIKT-IGE-R/L-16-2-T2.5-H
AIKT-IGE-R/L-10-2-T3-H
AIKT-IGE-R/L-16-3-T2.5-H
AIKT-IGE-R/L-16-3-T2.5-D20

ISCR (GEP) UCUNA UYGUNDUR
COMPATIBLE WITH ISCR (GEP) INSERT



AIKT-SGC-R-25-3-T6
AIKT-SGC-R-32-3-T6
AIKT-SGC-R-40-3-T6

SMTM (GCM) UCUNA UYGUNDUR
COMPATIBLE WITH SMTM (GCM) INSERT



AIKT-KM-R/L-20-2-T7
AIKT-KM-R/L-20-3-T7
AIKT-KM-R/L-25-3-T10
AIKT-KM-R/L-32-3-T12
AIKT-KM-R/L-40-3-T12
AIKT-KM-R/L-20-4-T7

KNMTL (A4) UCUNA UYGUNDUR
COMPATIBLE WITH KNMTL (A4) INSERT



AIKT-GP-R/L-20-2-T4
AIKT-GP-R/L-25-2-T6
AIKT-GP-R/L-20-3-T6
AIKT-GP-R/L-25-3-T6
AIKT-GP-R/L-32-3-T6
AIKT-GP-R/L-20-4-T6
AIKT-GP-R/L-25-4-T6
AIKT-GP-R/L-32-4-T6

PLBT (GP) UCUNA UYGUNDUR
COMPATIBLE WITH PLBT (GP) INSERT



AIKT-TD-R-16-2-T8.5-H
AIKT-TD-R-20-3-T6-H
AIKT-TD-R-25-3-T6-H
AIKT-TD-R-32-3-T5-H

TGTC (TD) UCUNA UYGUNDUR
COMPATIBLE WITH TGTC (TD) INSERT



Takma Uçlu Matkaplar / U-Drill System

D2 WCM - (ISO)



ATUM 16XD2 WCM. 030208
ATUM 16.5XD2 WCM. 030208
ATUM 17XD2 WCM. 030208
ATUM 17.5XD2 WCM. 030208
ATUM 18XD2 WCM. 030208
ATUM 18.5XD2 WCM. 030208
ATUM 19XD2 WCM. 030208
ATUM 19.5XD2 WCM. 030208
ATUM 20XD2 WCM. 040208
ATUM 20.5XD2 WCM. 040208
ATUM 21XD2 WCM. 040208
ATUM 21.5XD2 WCM. 040208
ATUM 22XD2 WCM. 040208
ATUM 22.5XD2 WCM. 040208
ATUM 23XD2 WCM. 040208
ATUM 23.5XD2 WCM. 040208
ATUM 24XD2 WCM. 050308
ATUM 24.5XD2 WCM. 050308
ATUM 25XD2 WCM. 050308
ATUM 25.5XD2 WCM. 050308
ATUM 26XD2 WCM. 050308
ATUM 26.5XD2 WCM. 050308
ATUM 27XD2 WCM. 050308
ATUM 27.5XD2 WCM. 050308
ATUM 28XD2 WCM. 050308
ATUM 28.5XD2 WCM. 050308
ATUM 29XD2 WCM. 050308
ATUM 29.5XD2 WCM. 050308
ATUM 30XD2 WCM. 06T308
ATUM 31XD2 WCM. 06T308
ATUM 32XD2 WCM. 06T308
ATUM 33XD2 WCM. 06T308
ATUM 34XD2 WCM. 06T308
ATUM 35XD2 WCM. 06T308
ATUM 36XD2 WCM. 06T308
ATUM 37XD2 WCM. 06T308
ATUM 38XD2 WCM. 06T308
ATUM 39XD2 WCM. 06T308
ATUM 40XD2 WCM. 06T308
ATUM 41XD2 WCM. 06T308
ATUM 42XD2 WCM. 06T308
ATUM 43XD2 WCM. 06T308
ATUM 44XD2 WCM. 06T308
ATUM 45XD2 WCM. 080412
ATUM 46XD2 WCM. 080412
ATUM 47XD2 WCM. 080412
ATUM 48XD2 WCM. 080412
ATUM 49XD2 WCM. 080412
ATUM 50XD2 WCM. 080412
ATUM 51XD2 WCM. 080412
ATUM 52XD2 WCM. 080412
ATUM 53XD2 WCM. 080412
ATUM 54XD2 WCM. 080412
ATUM 55XD2 WCM. 080412
ATUM 56XD2 WCM. 080412
ATUM 57XD2 WCM. 080412
ATUM 58XD2 WCM. 080412
ATUM 59XD2 WCM. 080412
ATUM 60XD2 WCM. 080412

D3 WCM - (ISO)



ATUM 16XD3 WCM. 030208
ATUM 16.5XD3 WCM. 030208
ATUM 17XD3 WCM. 030208
ATUM 17.5XD3 WCM. 030208
ATUM 18XD3 WCM. 030208
ATUM 18.5XD3 WCM. 030208
ATUM 19XD3 WCM. 030208
ATUM 19.5XD3 WCM. 030208
ATUM 20XD3 WCM. 040208
ATUM 20.5XD3 WCM. 040208
ATUM 21XD3 WCM. 040208
ATUM 21.5XD3 WCM. 040208
ATUM 22XD3 WCM. 040208
ATUM 22.5XD3 WCM. 040208
ATUM 23XD3 WCM. 040208
ATUM 23.5XD3 WCM. 040208
ATUM 24XD3 WCM. 050308
ATUM 24.5XD3 WCM. 050308
ATUM 25XD3 WCM. 050308
ATUM 25.5XD3 WCM. 050308
ATUM 26XD3 WCM. 050308
ATUM 26.5XD3 WCM. 050308
ATUM 27XD3 WCM. 050308
ATUM 27.5XD3 WCM. 050308
ATUM 28XD3 WCM. 050308
ATUM 28.5XD3 WCM. 050308
ATUM 29XD3 WCM. 050308
ATUM 29.5XD3 WCM. 050308
ATUM 30XD3 WCM. 06T308
ATUM 30.5XD3 WCM. 06T308
ATUM 31XD3 WCM. 06T308
ATUM 31.5XD3 WCM. 06T308
ATUM 32XD3 WCM. 06T308
ATUM 32.5XD3 WCM. 06T308
ATUM 33XD3 WCM. 06T308
ATUM 33.5XD3 WCM. 06T308
ATUM 34XD3 WCM. 06T308
ATUM 34.5XD3 WCM. 06T308
ATUM 35XD3 WCM. 06T308
ATUM 35.5XD3 WCM. 06T308
ATUM 36XD3 WCM. 06T308
ATUM 36.5XD3 WCM. 06T308
ATUM 37XD3 WCM. 06T308
ATUM 37.5XD3 WCM. 06T308
ATUM 38XD3 WCM. 06T308
ATUM 38.5XD3 WCM. 06T308
ATUM 39XD3 WCM. 06T308
ATUM 39.5XD3 WCM. 06T308
ATUM 40XD3 WCM. 06T308
ATUM 40.5XD3 WCM. 06T308
ATUM 41XD3 WCM. 06T308
ATUM 41.5XD3 WCM. 06T308
ATUM 42XD3 WCM. 06T308
ATUM 42.5XD3 WCM. 06T308
ATUM 43XD3 WCM. 06T308
ATUM 43.5XD3 WCM. 06T308
ATUM 44XD3 WCM. 06T308
ATUM 44.5XD3 WCM. 06T308
ATUM 45XD3 WCM. 080412

Takma Uçlu Matkaplar / U-Drill System
D3 WCM - (ISO)

ATUM 45.5XD3 WCM. 080412
 ATUM 46XD3 WCM. 080412
 ATUM 47XD3 WCM. 080412
 ATUM 48XD3 WCM. 080412
 ATUM 49XD3 WCM. 080412
 ATUM 50XD3 WCM. 080412
 ATUM 51XD3 WCM. 080412
 ATUM 52XD3 WCM. 080412
 ATUM 53XD3 WCM. 080412
 ATUM 54XD3 WCM. 080412
 ATUM 55XD3 WCM. 080412
 ATUM 56XD3 WCM. 080412
 ATUM 57XD3 WCM. 080412
 ATUM 58XD3 WCM. 080412
 ATUM 59XD3 WCM. 080412
 ATUM 60XD3 WCM. 080412

D4 WCM - (ISO)

ATUM 16XD4 WCM. 030208
 ATUM 17XD4 WCM. 030208
 ATUM 17.5XD4 WCM. 030208
 ATUM 18XD4 WCM. 030208
 ATUM 19XD4 WCM. 030208
 ATUM 20XD4 WCM. 040208
 ATUM 21XD4 WCM. 040208
 ATUM 22XD4 WCM. 040208
 ATUM 22.5XD4 WCM. 040208
 ATUM 23XD4 WCM. 040208
 ATUM 24XD4 WCM. 050308
 ATUM 25XD4 WCM. 050308
 ATUM 26XD4 WCM. 050308
 ATUM 26.5XD4 WCM. 050308
 ATUM 27XD4 WCM. 050308
 ATUM 28XD4 WCM. 050308
 ATUM 28.5XD4 WCM. 050308
 ATUM 29XD4 WCM. 050308
 ATUM 30XD4 WCM. 06T308
 ATUM 31XD4 WCM. 06T308
 ATUM 32XD4 WCM. 06T308
 ATUM 33XD4 WCM. 06T308
 ATUM 33.5XD4 WCM. 06T308
 ATUM 34XD4 WCM. 06T308
 ATUM 35XD4 WCM. 06T308
 ATUM 36XD4 WCM. 06T308
 ATUM 37XD4 WCM. 06T308
 ATUM 38XD4 WCM. 06T308
 ATUM 38.5XD4 WCM. 06T308
 ATUM 39XD4 WCM. 06T308
 ATUM 40XD4 WCM. 06T308
 ATUM 41XD4 WCM. 06T308
 ATUM 42XD4 WCM. 06T308
 ATUM 43XD4 WCM. 06T308
 ATUM 44XD4 WCM. 06T308
 ATUM 45XD4 WCM. 080412
 ATUM 46XD4 WCM. 080412
 ATUM 47XD4 WCM. 080412
 ATUM 48XD4 WCM. 080412
 ATUM 49XD4 WCM. 080412
 ATUM 50XD4 WCM. 080412

D2 SP. - SPMG (TGTC)

ATUM 12.5XD2 SP. 050204
 ATUM 13XD2 SP. 050204
 ATUM 13.5XD2 SP. 050204
 ATUM 14XD2 SP. 050204
 ATUM 14.5XD2 SP. 050204
 ATUM 15XD2 SP. 050204
 ATUM 15.5XD2 SP. 060204
 ATUM 16XD2 SP. 060204
 ATUM 16.5XD2 SP. 060204
 ATUM 17XD2 SP. 060204
 ATUM 17.5XD2 SP. 060204
 ATUM 18XD2 SP. 060204
 ATUM 18.5XD2 SP. 060204
 ATUM 19XD2 SP. 060204
 ATUM 19.5XD2 SP. 060204
 ATUM 20XD2 SP. 060204
 ATUM 20.5XD2 SP. 060204
 ATUM 21XD2 SP. 060204
 ATUM 21.5XD2 SP. 060204
 ATUM 22XD2 SP. 07T308
 ATUM 22.5XD2 SP. 07T308
 ATUM 23XD2 SP. 07T308
 ATUM 23.5XD2 SP. 07T308
 ATUM 24XD2 SP. 07T308
 ATUM 24.5XD2 SP. 07T308
 ATUM 25XD2 SP. 07T308
 ATUM 25.5XD2 SP. 07T308
 ATUM 26XD2 SP. 07T308
 ATUM 26.5XD2 SP. 07T308
 ATUM 27XD2 SP. 07T308
 ATUM 27.5XD2 SP. 07T308
 ATUM 28XD2 SP. 090408
 ATUM 28.5XD2 SP. 090408
 ATUM 29XD2 SP. 090408
 ATUM 29.5XD2 SP. 090408
 ATUM 30XD2 SP. 090408
 ATUM 31XD2 SP. 090408
 ATUM 32XD2 SP. 090408
 ATUM 33XD2 SP. 090408
 ATUM 34XD2 SP. 110408
 ATUM 35XD2 SP. 110408
 ATUM 36XD2 SP. 110408
 ATUM 37XD2 SP. 110408
 ATUM 38XD2 SP. 110408
 ATUM 39XD2 SP. 110408
 ATUM 40XD2 SP. 110408
 ATUM 41XD2 SP. 110408
 ATUM 42XD2 SP. 140512
 ATUM 43XD2 SP. 140512
 ATUM 44XD2 SP. 140512
 ATUM 45XD2 SP. 140512
 ATUM 46XD2 SP. 140512
 ATUM 47XD2 SP. 140512
 ATUM 48XD2 SP. 140512
 ATUM 49XD2 SP. 140512
 ATUM 50XD2 SP. 140512



Takma Uçlu Matkaplar / U-Drill System

D3 SP. - SPMG (TGTC)



ATUM 12.5XD3 SP.. 050204
ATUM 13XD3 SP.. 050204
ATUM 13.5XD3 SP.. 050204
ATUM 14XD3 SP.. 050204
ATUM 14.5XD3 SP.. 050204
ATUM 15XD3 SP.. 050204
ATUM 15.5XD3 SP.. 060204
ATUM 16XD3 SP.. 060204
ATUM 16.5XD3 SP.. 060204
ATUM 17XD3 SP.. 060204
ATUM 17.5XD3 SP.. 060204
ATUM 18XD3 SP.. 060204
ATUM 18.5XD3 SP.. 060204
ATUM 19XD3 SP.. 060204
ATUM 19.5XD3 SP.. 060204
ATUM 20XD3 SP.. 060204
ATUM 20.5XD3 SP.. 060204
ATUM 21XD3 SP.. 060204
ATUM 21.5XD3 SP.. 060204
ATUM 22XD3 SP.. 07T308
ATUM 22.5XD3 SP.. 07T308
ATUM 23XD3 SP.. 07T308
ATUM 23.5XD3 SP.. 07T308
ATUM 24XD3 SP.. 07T308
ATUM 24.5XD3 SP.. 07T308
ATUM 25XD3 SP.. 07T308
ATUM 25.5XD3 SP.. 07T308
ATUM 26XD3 SP.. 07T308
ATUM 26.5XD3 SP.. 07T308
ATUM 27XD3 SP.. 07T308
ATUM 27.5XD3 SP.. 07T308
ATUM 28XD3 SP.. 090408
ATUM 28.5XD3 SP.. 090408
ATUM 29XD3 SP.. 090408
ATUM 29.5XD3 SP.. 090408
ATUM 30XD3 SP.. 090408
ATUM 30.5XD3 SP.. 090408
ATUM 31XD3 SP.. 090408
ATUM 31.5XD3 SP.. 090408
ATUM 32XD3 SP.. 090408
ATUM 32.5XD3 SP.. 090408
ATUM 33XD3 SP.. 090408
ATUM 33.5XD3 SP.. 090408
ATUM 34XD3 SP.. 110408
ATUM 34.5XD3 SP.. 110408
ATUM 35XD3 SP.. 110408
ATUM 35.5XD3 SP.. 110408
ATUM 36XD3 SP.. 110408
ATUM 36.5XD3 SP.. 110408
ATUM 37XD3 SP.. 110408
ATUM 37.5XD3 SP.. 110408
ATUM 38XD3 SP.. 110408
ATUM 38.5XD3 SP.. 110408
ATUM 39XD3 SP.. 110408
ATUM 39.5XD3 SP.. 110408
ATUM 40XD3 SP.. 110408
ATUM 40.5XD3 SP.. 110408

D3 SP. - SPMG (TGTC)



ATUM 41XD3 SP.. 110408
ATUM 41.5XD3 SP.. 110408
ATUM 42XD3 SP.. 140512
ATUM 42.5XD3 SP.. 140512
ATUM 43XD3 SP.. 140512
ATUM 43.5XD3 SP.. 140512
ATUM 44XD3 SP.. 140512
ATUM 44.5XD3 SP.. 140512
ATUM 45XD3 SP.. 140512
ATUM 45.5XD3 SP.. 140512
ATUM 46XD3 SP.. 140512
ATUM 47XD3 SP.. 140512
ATUM 48XD3 SP.. 140512
ATUM 49XD3 SP.. 140512
ATUM 50XD3 SP.. 140512
ATUM 51XD3 SP.. 140512
ATUM 52XD3 SP.. 140512

D4 SP. - SPMG (TGTC)



ATUM 13XD4 SP.. 050204
ATUM 14XD4 SP.. 050204
ATUM 15XD4 SP.. 050204
ATUM 16XD4 SP.. 060204
ATUM 17XD4 SP.. 060204
ATUM 17.5XD4 SP.. 060204
ATUM 18XD4 SP.. 060204
ATUM 19XD4 SP.. 060204
ATUM 19.5XD4 SP.. 060204
ATUM 20XD4 SP.. 060204
ATUM 21XD4 SP.. 060204
ATUM 22XD4 SP.. 07T308
ATUM 23XD4 SP.. 07T308
ATUM 23.5XD4 SP.. 07T308
ATUM 24XD4 SP.. 07T308
ATUM 25XD4 SP.. 07T308
ATUM 26XD4 SP.. 07T308
ATUM 27XD4 SP.. 07T308
ATUM 27.5XD4 SP.. 07T308
ATUM 28XD4 SP.. 090408
ATUM 29XD4 SP.. 090408
ATUM 30XD4 SP.. 090408
ATUM 31XD4 SP.. 090408
ATUM 32XD4 SP.. 090408
ATUM 33XD4 SP.. 090408
ATUM 33.5XD4 SP.. 090408
ATUM 34XD4 SP.. 110408
ATUM 35XD4 SP.. 110408
ATUM 36XD4 SP.. 110408
ATUM 37XD4 SP.. 110408
ATUM 38XD4 SP.. 110408
ATUM 39XD4 SP.. 110408
ATUM 40XD4 SP.. 110408
ATUM 41XD4 SP.. 110408
ATUM 42XD4 SP.. 140512
ATUM 43XD4 SP.. 140512
ATUM 44XD4 SP.. 140512

Takma Uçlu Matkaplar / U-Drill System

D2 SPGT - (ZCC)



ATUM 12.5XD2 SPGT 050204
 ATUM 13XD2 SPGT 050204
 ATUM 13.5XD2 SPGT 050204
 ATUM 14XD2 SPGT 050204
 ATUM 15XD2 SPGT 050204
 ATUM 16XD2 SPGT 060204
 ATUM 16.5XD2 SPGT 060204
 ATUM 17XD2 SPGT 060204
 ATUM 17.5XD2 SPGT 060204
 ATUM 18XD2 SPGT 060204
 ATUM 19XD2 SPGT 060204
 ATUM 20XD2 SPGT 060204
 ATUM 22XD2 SPGT 07T308
 ATUM 22.5XD2 SPGT 07T308
 ATUM 23XD2 SPGT 07T308
 ATUM 24XD2 SPGT 07T308
 ATUM 25XD2 SPGT 07T308
 ATUM 26XD2 SPGT 07T308
 ATUM 28XD2 SPGT 090408
 ATUM 29XD2 SPGT 090408
 ATUM 30XD2 SPGT 090408
 ATUM 32XD2 SPGT 090408
 ATUM 35XD2 SPGT 110408
 ATUM 36XD2 SPGT 110408
 ATUM 40XD2 SPGT 110408

D3 SPGT - (ZCC)



ATUM 28.5XD3 SPGT 090408
 ATUM 29XD3 SPGT 090408
 ATUM 29.5XD3 SPGT 090408
 ATUM 30XD3 SPGT 090408
 ATUM 31XD3 SPGT 090408
 ATUM 32XD3 SPGT 090408
 ATUM 33XD3 SPGT 090408
 ATUM 34XD3 SPGT 110408
 ATUM 35XD3 SPGT 110408
 ATUM 37XD3 SPGT 110408
 ATUM 38XD3 SPGT 110408
 ATUM 39XD3 SPGT 110408
 ATUM 40XD3 SPGT 110408
 ATUM 42XD3 SPGT 140512
 ATUM 43XD3 SPGT 140512
 ATUM 44XD3 SPGT 140512
 ATUM 49XD3 SPGT 140512
 ATUM 50XD3 SPGT 140512

D3 SPGT - (ZCC)



ATUM 12.5XD3 SPGT 050204
 ATUM 13XD3 SPGT 050204
 ATUM 13.5XD3 SPGT 050204
 ATUM 14XD3 SPGT 050204
 ATUM 14.5XD3 SPGT 050204
 ATUM 15XD3 SPGT 050204
 ATUM 15.5XD3 SPGT 060204
 ATUM 16XD3 SPGT 060204
 ATUM 16.5XD3 SPGT 060204
 ATUM 17XD3 SPGT 060204
 ATUM 17.5XD3 SPGT 060204
 ATUM 18XD3 SPGT 060204
 ATUM 18.5XD3 SPGT 060204
 ATUM 19XD3 SPGT 060204
 ATUM 19.5XD3 SPGT 060204
 ATUM 20XD3 SPGT 060204
 ATUM 20.5XD3 SPGT 060204
 ATUM 21XD3 SPGT 060204
 ATUM 21.5XD3 SPGT 060204
 ATUM 22XD3 SPGT 07T308
 ATUM 22.5XD3 SPGT 07T308
 ATUM 23XD3 SPGT 07T308
 ATUM 23.5XD3 SPGT 07T308
 ATUM 24XD3 SPGT 07T308
 ATUM 24.5XD3 SPGT 07T308
 ATUM 25XD3 SPGT 07T308
 ATUM 25.5XD3 SPGT 07T308
 ATUM 26XD3 SPGT 07T308
 ATUM 26.5XD3 SPGT 07T308
 ATUM 27XD3 SPGT 07T308
 ATUM 27.5XD3 SPGT 07T308
 ATUM 28XD3 SPGT 090408

D4 SPGT - (ZCC)



ATUM 13XD4 SPGT 050204
 ATUM 14XD4 SPGT 050204
 ATUM 15XD4 SPGT 050204
 ATUM 16XD4 SPGT 060204
 ATUM 17XD4 SPGT 060204
 ATUM 17.5XD4 SPGT 060204
 ATUM 18XD4 SPGT 060204
 ATUM 19XD4 SPGT 060204
 ATUM 19.5XD4 SPGT 060204
 ATUM 20XD4 SPGT 060204
 ATUM 21XD4 SPGT 060204
 ATUM 22XD4 SPGT 07T308
 ATUM 23XD4 SPGT 07T308
 ATUM 23.5XD4 SPGT 07T308
 ATUM 24XD4 SPGT 07T308
 ATUM 25XD4 SPGT 07T308
 ATUM 26XD4 SPGT 07T308
 ATUM 27.5XD4 SPGT 07T308
 ATUM 28XD4 SPGT 090408
 ATUM 29XD4 SPGT 090408
 ATUM 30XD4 SPGT 090408
 ATUM 33.5XD4 SPGT 090408
 ATUM 38XD4 SPGT 110408

D3 SO.. - SOMX-SOMT (ISCR)



ATUM 14XD3 SO.. 050204
 ATUM 15XD3 SO.. 050204
 ATUM 16XD3 SO.. 050204
 ATUM 16.5XD3 SO.. 050204
 ATUM 17XD3 SO.. 050204
 ATUM 17.5XD3 SO.. 050204
 ATUM 18XD3 SO.. 060304
 ATUM 19XD3 SO.. 060204
 ATUM 20XD3 SO.. 060304
 ATUM 22XD3 SO.. 070305
 ATUM 22.5XD3 SO.. 070305
 ATUM 23XD3 SO.. 070305
 ATUM 24XD3 SO.. 070305
 ATUM 25XD3 SO.. 09T306
 ATUM 26XD3 SO.. 09T306
 ATUM 27XD3 SO.. 09T306
 ATUM 29XD3 SO.. 09T306
 ATUM 30XD3 SO.. 09T306



Takma Uçlu Matkaplar / U-Drill System

D3 SO.. - SOMX-SOMT (ISCR)



ATUM 31XD3 SO.. 09T306
ATUM 33XD3 SO.. 09T306
ATUM 35XD3 SO.. 120408
ATUM 36XD3 SO.. 120408
ATUM 37XD3 SO.. 120408
ATUM 38XD3 SO.. 120408
ATUM 39XD3 SO.. 120408
ATUM 40XD3 SO.. 120408
ATUM 43XD3 SO.. 120408

D4 SO.. - SOMX-SOMT (ISCR)



ATUM 14XD4 SO.. 050204
ATUM 14.5XD4 SO.. 050204
ATUM 15.5XD4 SO.. 050204
ATUM 17XD4 SO.. 050204
ATUM 19XD4 SO.. 060304
ATUM 19.5XD4 SO.. 060304
ATUM 20XD4 SO.. 060304
ATUM 22XD4 SO.. 070305
ATUM 22.5XD4 SO.. 070305
ATUM 23XD4 SO.. 070305
ATUM 24XD4 SO.. 070305
ATUM 25XD4 SO.. 09T306
ATUM 27XD4 SO.. 09T306
ATUM 28XD4 SO.. 09T306
ATUM 29XD4 SO.. 09T306
ATUM 30XD4 SO.. 09T306
ATUM 31XD4 SO.. 09T306
ATUM 33XD4 SO.. 09T306
ATUM 34XD4 SO.. 09T306
ATUM 35XD4 SO.. 120408

D2 KDR - SPMT-XOMT (KRLY)



ATUM 14XD2 KDR 0502..
ATUM 18XD2 KDR 0602..
ATUM 20XD2 KDR 07T2..
ATUM 22XD2 KDR 07T2..
ATUM 24XD2 KDR 0903..
ATUM 25XD2 KDR 0903..
ATUM 26XD2 KDR 0903..
ATUM 28XD2 KDR 0903..
ATUM 30XD2 KDR 11T3..
ATUM 32XD2 KDR 11T3..
ATUM 34XD2 KDR 11T3..

D4 KDR - SPMT-XOMT (KRLY)



ATUM 14XD4 KDR 0502..
ATUM 14.5XD4 KDR 0502..
ATUM 15.5XD4 KDR 0502..
ATUM 16XD4 KDR 0502..
ATUM 17XD4 KDR 0602..
ATUM 17.5XD4 KDR 0602..
ATUM 18XD4 KDR 0602..
ATUM 18.5XD4 KDR 0602..
ATUM 19XD4 KDR 0602..
ATUM 20XD4 KDR 07T2..
ATUM 21XD4 KDR 07T2..
ATUM 22XD4 KDR 07T2..
ATUM 24XD4 KDR 0903..
ATUM 25XD4 KDR 0903..

D3 KDR - SPMT-XOMT (KRLY)



ATUM 12.5XD3 KDR 0402..
ATUM 13XD3 KDR 0402..
ATUM 14XD3 KDR 0502..
ATUM 14.5XD3 KDR 0502..
ATUM 15XD3 KDR 0502..
ATUM 15.5XD3 KDR 0502..
ATUM 16XD3 KDR 0502..
ATUM 16.5XD3 KDR 0602..
ATUM 17XD3 KDR 0602..
ATUM 17.5XD3 KDR 0602..
ATUM 18XD3 KDR 0602..
ATUM 18.5XD3 KDR 0602..
ATUM 19XD3 KDR 0602..
ATUM 19.5XD3 KDR 0602..
ATUM 20XD3 KDR 07T2..
ATUM 20.5XD3 KDR 07T2..
ATUM 21XD3 KDR 07T2..
ATUM 22XD3 KDR 07T2..
ATUM 23XD3 KDR 07T2..
ATUM 23.5XD3 KDR 07T2..
ATUM 24XD3 KDR 0903..
ATUM 24.5XD3 KDR 0903..
ATUM 25XD3 KDR 0903..
ATUM 26XD3 KDR 0903..
ATUM 27XD3 KDR 0903..
ATUM 28XD3 KDR 0903..
ATUM 29XD3 KDR 0903..
ATUM 30XD3 KDR 11T3..
ATUM 32XD3 KDR 11T3..
ATUM 33XD3 KDR 11T3..
ATUM 34XD3 KDR 11T3..
ATUM 35XD3 KDR 11T3..
ATUM 37XD3 KDR 1304..
ATUM 38XD3 KDR 1304..
ATUM 39XD3 KDR 1304..
ATUM 40XD3 KDR 1304..

D2 SOMT - (TGTC)



ATUM 14XD2 SOMT 050204
ATUM 16XD2 SOMT 050204
ATUM 17XD2 SOMT 060204
ATUM 18XD2 SOMT 060204
ATUM 20XD2 SOMT 070306
ATUM 22XD2 SOMT 070306
ATUM 24XD2 SOMT 08T306
ATUM 25XD2 SOMT 08T306
ATUM 26XD2 SOMT 08T306
ATUM 27XD2 SOMT 09T308
ATUM 28XD2 SOMT 09T308
ATUM 30XD2 SOMT 09T308
ATUM 32XD2 SOMT 11T308
ATUM 33XD2 SOMT 11T308
ATUM 34XD2 SOMT 11T308
ATUM 35XD2 SOMT 11T308
ATUM 37XD2 SOMT 130408
ATUM 38XD2 SOMT 130408
ATUM 40XD2 SOMT 130408
ATUM 45XD2 SOMT 150510

Delik Delme ve İşleme Takımları / Drilling and Holemaking Tools

D3 SOMT - (TGTC)



ATUM 13XD3 SOMT 050204
 ATUM 14XD3 SOMT 050204
 ATUM 14.5XD3 SOMT 050204
 ATUM 15XD3 SOMT 050204
 ATUM 15.5XD3 SOMT 050204
 ATUM 16XD3 SOMT 050204
 ATUM 16.5XD3 SOMT 060204
 ATUM 17XD3 SOMT 060204
 ATUM 17.5XD3 SOMT 060204
 ATUM 18XD3 SOMT 060204
 ATUM 18.5XD3 SOMT 060204
 ATUM 19XD3 SOMT 060204
 ATUM 19.5XD3 SOMT 070306
 ATUM 20XD3 SOMT 070306
 ATUM 20.5XD3 SOMT 070306
 ATUM 21XD3 SOMT 070306
 ATUM 22XD3 SOMT 070305
 ATUM 22.5XD3 SOMT 08T306
 ATUM 23XD3 SOMT 08T306
 ATUM 23.5XD3 SOMT 08T306
 ATUM 24XD3 SOMT 08T306
 ATUM 24.5XD3 SOMT 08T306
 ATUM 25XD3 SOMT 08T306
 ATUM 26XD3 SOMT 08T306
 ATUM 27XD3 SOMT 09T308
 ATUM 27.5XD3 SOMT 09T308
 ATUM 28XD3 SOMT 09T308
 ATUM 29XD3 SOMT 09T308
 ATUM 30XD3 SOMT 09T308
 ATUM 32XD3 SOMT 11T308
 ATUM 33XD3 SOMT 11T308
 ATUM 34XD3 SOMT 11T308
 ATUM 35XD3 SOMT 11T308
 ATUM 36XD3 SOMT 11T308
 ATUM 37XD3 SOMT 130408
 ATUM 38XD3 SOMT 130408
 ATUM 39XD3 SOMT 130408
 ATUM 40XD3 SOMT 130408
 ATUM 45XD3 SOMT 150510
 ATUM 49XD3 SOMT 150510
 ATUM 50XD3 SOMT 150510

D5 SOMT - (TGTC)



ATUM 13XD5 SOMT 050204
 ATUM 14XD5 SOMT 050204
 ATUM 15XD5 SOMT 050204
 ATUM 15.5XD5 SOMT 050204
 ATUM 16XD5 SOMT 050204
 ATUM 17.5XD5 SOMT 060204
 ATUM 18XD5 SOMT 060204
 ATUM 19XD5 SOMT 060204
 ATUM 19.5XD5 SOMT 070306
 ATUM 20XD5 SOMT 070306
 ATUM 21XD5 SOMT 070306
 ATUM 22XD5 SOMT 070306
 ATUM 23XD5 SOMT 08T306
 ATUM 24XD5 SOMT 08T306
 ATUM 25XD5 SOMT 08T306
 ATUM 26XD5 SOMT 08T306
 ATUM 27XD5 SOMT 09T308
 ATUM 28XD5 SOMT 09T308
 ATUM 29XD5 SOMT 09T308
 ATUM 30XD5 SOMT 09T308
 ATUM 33XD5 SOMT 11T308
 ATUM 34XD5 SOMT 11T308
 ATUM 35XD5 SOMT 11T308
 ATUM 36XD5 SOMT 11T308

D4 SOMT - (TGTC)



ATUM 14XD4 SOMT 050204
 ATUM 14.5XD4 SOMT 050204
 ATUM 16XD4 SOMT 050204
 ATUM 17XD4 SOMT 060204
 ATUM 17.5XD4 SOMT 060204
 ATUM 18XD4 SOMT 060204
 ATUM 19XD4 SOMT 060204
 ATUM 20XD4 SOMT 070306
 ATUM 21XD4 SOMT 070306
 ATUM 22XD4 SOMT 070306
 ATUM 24XD4 SOMT 08T306
 ATUM 25XD4 SOMT 08T306

Ekokes-Delik Delme, Delik İçi ve Dış Çap Tornalama Ekokes-Drilling, Boring and External Turning



CRTZT-İSCR-TGTC-KRLY UCUNA UYGUNDUR
 COMPATIBLE WITH CRTZT-İSCR-TGTC-KRLY INSERT

AEKR/L-D2.25X8 XC.. 040104
 AEKR/L-D2.25X10 XC.. 050204
 AEKR/L-D2.25X12 XC.. 060204
 AEKR/L-D2.25X14 XC.. 070304
 AEKR/L-D2.25X16 XC.. 080304
 AEKR/L-D2.25X18 XC.. 09T304
 AEKR/L-D2.25X20 XC.. 10T304
 AEKR/L-D2.25X25 XC.. 130404
 AEKR/L-D2.25X32 XC.. 170504

Eksantrik U-Drill Adaptörü / Excentric Adaptor For U-Drills



AET

AET-2025
 AET-2532
 AET-3240
 Ø+0.4 - Ø-0.2 ARASINDA
 ONDALIKLI OLARAK AYARLANABİLİR
 ÖR: Ø25 TAKIM = 24.8 ≈ 25.4 ARASI AYARLANABİLİR.
 CAN BE ADJUSTABLE BETWEEN
 Ø+0.4 - Ø-0.2 AS DECIMAL.
 FOR EXAMPLE: Ø25 TOOL;
 CAN BE ADJUSTABLE BETWEEN 24.8 ≈ 25.4

Delik Pahlama Bileziği / Drill Chamfering Ring Tools

ADCR	Takım Kodu / Tool Code
	ADCR-120-VB1103
	ADCR-125-VB1103
	ADCR-130-VB1103
	ADCR-135-VB1103
	ADCR-140-VB1103
	ADCR-145-VB1103
	ADCR-150-VB1103
	ADCR-155-VB1103
	ADCR-160-VB1103
	ADCR-165-VB1103
	ADCR-170-VB1103
	ADCR-175-VB1103
	ADCR-180-VB1103
	ADCR-185-VB1103
	ADCR-190-VB1103
	ADCR-195-VB1103
	ADCR-200-VB1103
	ADCR-205-VB1103
	ADCR-210-VB1103
	ADCR-215-VB1103
	ADCR-220-VB1103
	ADCR-225-VB1103
	ADCR-230-VB1103
	ADCR-235-VB1103
	ADCR-240-VB1103
	ADCR-245-VB1103
	ADCR-250-VB1103
	ADCR-255-VB1103
	ADCR-260-VB1103
	ADCR-265-VB1103
	ADCR-270-VB1103
	ADCR-275-VB1103
	ADCR-280-VB1103
	ADCR-285-VB1103
	ADCR-290-VB1103
	ADCR-295-VB1103
	ADCR-300-VB1103

Ayarlı Kaba Delik İşleme Baraları / Adjustable Rough Boring Heads

Takım Kodu / Tool Code	Dmin-Dmax
ABHR-D18x22-W16-L90-CC06	18-22
ABHR-D18x22-W16-L150-CC06	18-22
ABHR-D18x22-W16-L200-CC06	18-22
ABHR-D22x28-W20-L100-CC06	22-28
ABHR-D22x28-W20-L150-CC06	22-28
ABHR-D22x28-W20-L200-CC06	22-28
ABHR-D28x38-W20-L110-CC06	28-38
ABHR-D28x38-W20-L160-CC06	28-38
ABHR-D28x38-W20-L230-CC06	28-38
ABHR-D36x50-W25-L120-CC06	36-50
ABHR-D36x50-W25-L170-CC06	36-50
ABHR-D36x50-W25-L250-CC06	36-50
ABHR-D36x50-W25-L120-CC09	36-50
ABHR-D36x50-W25-L170-CC09	36-50
ABHR-D36x50-W25-L250-CC09	36-50
ABHR-D50x68-W32-L140-CC09	50-68
ABHR-D50x68-W32-L200-CC09	50-68
ABHR-D50x68-W32-L280-CC09	50-68
ABHR-D50x68-W32-L140-CC12	50-68
ABHR-D50x68-W32-L200-CC12	50-68
ABHR-D50x68-W32-L280-CC12	50-68
ABHR-D68x90-W32-L160-CC12	68-90
ABHR-D68x90-W32-L210-CC12	68-90
ABHR-D68x90-W32-L280-CC12	68-90
ABHR-D90x120-W32-L140-CC12	90-120
ABHR-D90x120-W40-L200-CC12	90-120
ABHR-D90x120-W40-L300-CC12	90-120
ABHR-D120x160-W40-L210-CC12	120-160
ABHR-D120x160-W40-L300-CC12	120-160
ABHR-D160x200-W40-L210-B-CC12	160-200
ABHR-D160x200-W40-L300-B-CC12	160-200

Ayarlı Kaba Delik İşleme Bara Kartuşları / Adjustable Rough Boring Heads Cartridge

Takım Kodu / Tool Code	Ölçü Aralığı-Boring Range
AKSR 18-22	18-22
AKSR 22-28	22-28
AKSR 28-38	28-38
AKSR 36-50	36-50
AKSR 36-50-09	36-50
AKSR 50-68	50-68
AKSR 50-68-12	50-68
AKSR 68-90	68-90
AKSR 90-120	90-120
AKSR 120-160	120-160
AKSR 160-800	160-800

Takım Kodu / Tool Code	Ölçü Aralığı-Boring Range
AKCR 28-38	28-38
AKCR 36-50	36-50
AKCR 36-50-09	36-50
AKCR 50-68	50-68
AKCR 50-68-12	50-68
AKCR 68-90	68-90
AKCR 90-120	90-120
AKCR 120-160	120-160
AKCR 160-800	160-800

Ayarlı Kaba Delik İşleme Bara Gövdesi / Adjustable Rough Boring Heads Body

Takım Kodu / Tool Code	Kartuş / Cartridge
ABHRS-D16x42-W16-L90	AK.. 18-22
ABHRS-D16x102-W16-L150	AK.. 18-22
ABHRS-D16x152-W16-L200	AK.. 18-22
ABHRS-D20x50-W20-L100	AK.. 22-28
ABHRS-D20x100-W20-L150	AK.. 22-28
ABHRS-D20x150-W20-L200	AK.. 22-28
ABHRS-D25x60-W20-L110	AK.. 28-38
ABHRS-D25x110-W20-L160	AK.. 28-38
ABHRS-D25x180-W20-L230	AK.. 28-38
ABHRS-D32x64-W25-L120	AK.. 36-50
ABHRS-D32x114-W25-L170	AK.. 36-50
ABHRS-D32x194-W25-L250	AK.. 36-50
ABHRS-D32x64-W25-L120	AK.. 36-50-09
ABHRS-D32x114-W25-L170	AK.. 36-50-09
ABHRS-D32x194-W25-L250	AK.. 36-50-09
ABHRS-D40x80-W32-L140	AK.. 50-68
ABHRS-D40x140-W32-L200	AK.. 50-68
ABHRS-D40x220-W32-L280	AK.. 50-68
ABHRS-D40x80-W32-L140	AK.. 50-68-12
ABHRS-D40x140-W32-L200	AK.. 50-68-12
ABHRS-D40x220-W32-L280	AK.. 50-68-12
ABHRS-D50x100-W32-L160	AK.. 68-90
ABHRS-D50x150-W32-L210	AK.. 68-90
ABHRS-D50x220-W32-L280	AK.. 68-90
ABHRS-D63x80-W32-L140	AK.. 90-120
ABHRS-D63x130-W40-L200	AK.. 90-120
ABHRS-D63x230-W40-L300	AK.. 90-120
ABHRS-D80x140-W40-L210	AK.. 120-160
ABHRS-D80x230-W40-L300	AK.. 120-160
ABHRS-D80x140-W40-L210	AK.. 160-800
ABHRS-D80x230-W40-L300	AK.. 160-800

Frezeleme Takımları / Milling Tools

Pah Frezeler / Chamfering Tools

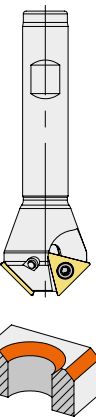
-°	ACM..-TC..	Uç / Insert	Takım Kodu / Tool Code	
	TCT 16T304		ACM10-TC16-D17X22-W16-L90-Z01	
			ACM15-TC16-D17X24-W16-L90-Z01	
			ACM15-TC16-D22X29-W16-L100-Z01	
			ACM15-TC16-D30X37-W20-L100-Z02	
			ACM15-TC16-D35X42-W20-L100-Z03	
			ACM15-TC16-D52X59-W25-L110-Z03	
			ACM17.5-TC16-D17X25-W16-L90-Z01	
			ACM18.5-TC16-D21.3X30-W20-L100-Z02	
			ACM20-TC16-D12X22-W16-L100-Z01	
			ACM20-TC16-D17X27-W16-L100-Z01	
			ACM20-TC16-D23X33-W20-L100-Z02	
			ACM20-TC16-D28X38-W20-L100-Z02	
			ACM20-TC16-D35X45-W20-L100-Z03	
			ACM20-TC16-D39X49-W20-L100-Z03	
			ACM20-TC16-D45X55-W25-L110-Z03	
			ACM20-TC16-D51X61-W25-L110-Z03	
			ACM22.5-TC16-D17X28-W16-L100-Z01	
			ACM25-TC16-D17X29-W16-L100-Z01	
			ACM30-TC16-D6X20-W16-L100-Z01	
			ACM30-TC16-D15X30-W16-L100-Z01	
			ACM30-TC16-D17.5X32.5-W20-L100-Z02	
			ACM30-TC16-D20X35-W16-L100-Z02	
			ACM30-TC16-D30X45-W20-L100-Z02	
			ACM30-TC16-D35X50-W20-L100-Z03	
			ACM30-TC16-D45X60-W25-L110-Z03	
			TCT 090204	ACM45-TC09-D7X18-W16-L100-Z02
			TCT 110204	ACM45-TC11-D11X24-W16-L100-Z02
			TCT 16T304	ACM45-TC16-D5X26-W16-L100-Z01
ACM45-TC16-D10X31-W16-L100-Z02				
ACM45-TC16-D10X31-W20-L100-Z02				
ACM45-TC16-D18X39-W16-L100-Z02				
ACM45-TC16-D18X39-W20-L100-Z02				
ACM45-TC16-D20X41-W20-L100-Z02				
ACM45-TC16-D30X51-W20-L100-Z02				
ACM55-TC16-D16X40-W20-L100-Z03				
ACM62-TC16-D14X40-W20-L100-Z03				
ACM72-TC16-D14X42-W20-L100-Z03				
				

45°	ACM45-SP11	Uç / Insert	Takım Kodu / Tool Code
		SPGT 110408 (For ZCC)	ACM45-SP1104-D12x26-W20-L150-Z01
			ACM45-SP1104-D25x39-W25-L150-Z02
			ACM45-SP1104-D32x46-W32-L150-Z03

Helis Pah Frezeleme Takımları / Helix Chamfer Milling Tools

-°	AHM..-AP16..	Uç / Insert	Takım Kodu / Tool Code
		AP. 1604.. (For ISO)	AHM15-AP16-D35x93-A27-Z0306-H
			AHM30-AP16-D35x87-A27-Z0306-H
			AHM45-AP16-D35x77-A27-Z0306-H
			AHM60-AP16-D35x65-A22-Z0306-H
			AHM75-AP16-D35x50-A22-Z0306-H

Silindirik Havşa Başlı Vida (DIN 974-1) Havşalarını Açma Frezeleri Countersink Milling Tool For Cylindrical Allen Head Screws (DIN 974-1)

-°	ACBM..	Uç / Insert	Takım Kodu / Tool Code
		CC. 0602.. (For ISO)	ACBM-CC06-D17X6-W16-L150-Z02 ACBM-CC06-D18X7-W16-L100-Z02-H ACBM-CC06-D18X7-W16-L160-Z02-H ACBM-CC06-D20X9-W20-L100-Z02-H ACBM-CC06-D20X9-W20-L160-Z02-H ACBM-CC09-D26X8.5-W25-L130-Z02-H
		CC. 09T3.. (For ISO)	ACBM-CC09-D26X8.5-W25-L200-Z02 ACBM-CC09-D33X15.5-W32-L130-Z02-H ACBM-CC09-D33X15.5-W32-L200-Z2
		SPMG 0602.. (For TCTC)	ACBM-SP06-D15X4-W16-L160-Z02-H

Diş Açma Frezeleme Takımları Thread Milling Tools

-°	ATM-C..	Uç / Insert	Takım Kodu / Tool Code
		C14 (For CPT)	ATM-C14-D14-W20-L100-Z01-H ATM-C21-D18-W20-L100-Z01-H ATM-C21-D21-W25-L125-Z01-H ATM-C21-D25-W20-L125-Z01-H ATM-C21-D28-W25-L90-Z01-H ATM-C21-D38-W32-L90-Z03-H ATM-C21-D38-W32-L120-Z03-H ATM-C21-D43-W32-L90-Z03-H
		C21 (For CPT)	
		C30 (For CPT)	ATM-C30-D29-W25-L150-Z01-H
-°	ATM-H..	Uç / Insert	Takım Kodu / Tool Code
		H23 (For CPT)	ATM-H23-D23-C25-L100-Z02-H
		H32 (For CPT)	ATM-H32-D32-C32-L130-Z05-H
60°	ATM60..	Uç / Insert	Takım Kodu / Tool Code
		TBGT 060102	ATM60-TB0601-D13-C10-L150-Z02-H
		TCT 090202	ATM60-TC0902-D20.5-C16-L150-Z02-H
		TCT 110202	ATM60-TC1102-D26-C20-L150-Z03-H
		TCT 16T304 (For ISO)	ATM60-TC16T3-D32-C25-L150-Z02-H ATM60-TC16T3-D40-C32-L250-Z03-H

Vidalı Takım Tutucular / Screwed Tool Holders

AVTT	Takım Kodu / Tool Code
	AVTT-D13-C16-M08-L100-H
	AVTT-D15-C16-M08-L130-H
	AVTT-D18-C20-M10-L130-H
	AVTT-D18-C20-M10-L160-H
	AVTT-D23-C25-M12-L150-H
	AVTT-D23-C25-M12-L200-H
	AVTT-D23-C25-M12-L250-H
	AVTT-D30-C32-M16-L150-H
	AVTT-D30-C32-M16-L200-H
	AVTT-D30-C32-M16-L250-H
	AVTT-D30-C32-M16-L300-H

S Sistem Yüzey Parmak Frezeler / S System End Mills

90°	AEM90-4N06	Uç / Insert	Takım Kodu / Tool Code
		4NKT 0603.. (For TGTC)	AEM90-4N06-D16-W16-L120-Z02-H
			AEM90-4N06-D16-W16-L160-Z02
			AEM90-4N06-D20-W16-L120-Z03-H
			AEM90-4N06-D20-W16-L160-Z03



Frezeleme Takımları / Milling Tools

S Sistem YüzeY Parmak Frezeler / S System End Mills

90°	AFM90-4N06	Uç / Insert	Takım Kodu / Tool Code
		4NKT 0603.. (For TGTC)	AFM90-4N06-D040-A16-Z05-H AFM90-4N06-D050-A22-Z06-H

S Sistem Modüler Parmak Frezeler / S System Modular End Mills (Screw Type Tools)

90°	AEM90-AD1505D	Uç / Insert	Takım Kodu / Tool Code
		ADKT 150508 (For DJT)	AEM90-AD1505D-D25-M12-L43-Z02-H AEM90-AD1505D-D32-M16-L43-Z03-H

S Sistem YüzeY Parmak Frezeler / S System End Mills

90°	AEM90-3P..	Uç / Insert	Takım Kodu / Tool Code
		3P.T 100408 (For TGTC)	AEM90-3P1004-D20-W20-L150-Z02 AEM90-3P1004-D25-W25-L150-Z03
		3P.T 150508 (For TGTC)	AEM90-3P1505-D32-W32-L150-Z03 AEM90-3P1505-D40-W32-L150-Z04

YüzeY Frezeler / Face Milling Tools

90°	AFM90-AD1505D	Uç / Insert	Takım Kodu / Tool Code
		ADKT 150508 (For DJT)	AEM90-AD1505D-D050-A22-Z05-H AEM90-AD1505D-D063-A27-Z06-H AEM90-AD1505D-D080-A27-Z08-H AEM90-AD1505D-D100-A32-Z08-H AEM90-AD1505D-D125-B40-Z09

YüzeY Frezeler / Face Milling Tools

90°	AFM90-3P..	Uç / Insert	Takım Kodu / Tool Code
		3PKT 1004..	AFM90-3P1004-D040-A16-Z05-H AFM90-3P1004-D050-A22-Z06-H AFM90-3P1505-D050-A22-Z04-H AFM90-3P1505-D050-A22-Z05-H AFM90-3P1505-D063-A22-Z04-H AFM90-3P1505-D063-A22-Z06-H AFM90-3P1505-D080-A27-Z07-H AFM90-3P1505-D100-A32-Z08-H AFM90-3P1505-D125-B40-Z10
		3PKT 1505.. (For TGTC)	

S Sistem YüzeY Parmak Frezeler / S System End Mills

90°	AEM90-AD15	Uç / Insert	Takım Kodu / Tool Code
		AD.. 1505.. (For ISCR)	AEM90-AD1505-D25-W25-L150-Z02 AEM90-AD1505-D30-W25-L150-Z03 AEM90-AD1505-D32-W32-L150-Z03

YüzeY Frezeler / Face Milling Tools

90°	AFM90-490R14	Uç / Insert	Takım Kodu / Tool Code
		490R-1404.. (For SNDVK)	AFM90-490R14-D050-A22-Z04-H AFM90-490R14-D063-A22-Z05-H AFM90-490R14-D080-A27-Z07-H

YüzeY Frezeler / Face Milling Tools

90°	AFM90-AD1505	Uç / Insert	Takım Kodu / Tool Code
		AD.. 1505.. (For ISCR)	AEM90-AD1505-D040-A16-Z04-H AEM90-AD1505-D050-A22-Z05-H AEM90-AD1505-D063-A22-Z06-H AEM90-AD1505-D080-A27-Z07-H AEM90-AD1505-D100-A32-Z08-H AEM90-AD1505-D125-B40-Z09

S Sistem YüzeY Parmak Frezeler / S System End Mills

90°	AEM90-AD07	Uç / Insert	Takım Kodu / Tool Code
		ADMX 0702.. (For PRMT)	AEM90-AD07-D10-C10-L80-Z02-H AEM90-AD07-D12-C12-L90-Z03-H AEM90-AD07-D16-C16-L110-Z04-H AEM90-AD07-D20-C20-L125-Z05-H AEM90-AD07-D25-C25-L140-Z06-H

S Sistem YüzeY Parmak Frezeler / S System End Mills

90°	AEM90-AD..	Uç / Insert	Takım Kodu / Tool Code
		ADMT 0803.. (For WLTR)	AEM90-AD0803-D16-W16-L150-Z02 AEM90-AD0803-D17-W16-L150-Z02 AEM90-AD0803-D17-W16-L200-Z02 AEM90-AD0803-D20-W20-L150-Z03 AEM90-AD0803-D21-W20-L200-Z03 AEM90-AD10T3-D16-W16-L100-Z02-H AEM90-AD10T3-D16-W16-L150-Z02 AEM90-AD10T3-D16-C16-L200-Z02 AEM90-AD10T3-D17-W16-L150-Z02 AEM90-AD10T3-D17-W16-L200-Z02 AEM90-AD10T3-D20-W20-L70-Z03 AEM90-AD10T3-D20-W20-L100-Z03-H AEM90-AD10T3-D20-C20-L150-Z03 AEM90-AD10T3-D20-W20-L150-Z03 AEM90-AD10T3-D20-C20-L200-Z03 AEM90-AD10T3-D25-W25-L100-Z03-H AEM90-AD10T3-D25-W25-L100-Z04-H AEM90-AD10T3-D25-W25-L150-Z03
		ADMT 10T3.. (For WLTR)	AEM90-AD1204-D20-W20-L150-Z02 AEM90-AD1204-D21-C20-L150-Z02 AEM90-AD1204-D22-C20-L150-Z02 AEM90-AD1204-D25-W25-L150-Z03 AEM90-AD1204-D26-W25-L180-Z03 AEM90-AD1204-D32-W32-L150-Z04
		ADMT 1204.. (For WLTR)	AEM90-AD1606-D25-W25-L150-Z02 AEM90-AD1606-D32-W32-L150-Z03
		ADMT 1606.. (For WLTR)	

S Sistem YüzeY Parmak Frezeler / S System End Mills

90°	AEM90-AD..	Uç / Insert	Takım Kodu / Tool Code
		ADMT 1003.. (For DJT)	AEM90-AD1003-D16-C16-L150-Z02 AEM90-AD1003-D17-C16-L150-Z02 AEM90-AD1003-D20-C20-L200-Z03 AEM90-AD1003-D21-C20-L150-Z03 AEM90-AD1003-D21-C20-L200-Z03 AEM90-AD1003-D25-C25-L200-Z03 AEM90-AD1003-D26-C25-L150-Z03 AEM90-AD1003-D26-C25-L200-Z03 AEM90-AD1505D-D25-W25-L150-Z02 AEM90-AD1505D-D32-W32-L150-Z03
		ADKT 150508 (For DJT)	

S Sistem YüzeY Parmak Frezeler / S System End Mills

90°	AEM90-AD..	Uç / Insert	Takım Kodu / Tool Code
		ADMT 1003.. (For DJT)	AEM90-AD1003-D16-C16-L150-Z02 AEM90-AD1003-D17-C16-L150-Z02 AEM90-AD1003-D20-C20-L200-Z03 AEM90-AD1003-D21-C20-L150-Z03 AEM90-AD1003-D21-C20-L200-Z03 AEM90-AD1003-D25-C25-L200-Z03 AEM90-AD1003-D26-C25-L150-Z03 AEM90-AD1003-D26-C25-L200-Z03 AEM90-AD1505D-D25-W25-L150-Z02 AEM90-AD1505D-D32-W32-L150-Z03
		ADMT 1003.. (For DJT)	
		ADMT 1204.. (For WLTR)	AEM90-AD1204-D20-W20-L150-Z02 AEM90-AD1204-D21-C20-L150-Z02 AEM90-AD1204-D22-C20-L150-Z02 AEM90-AD1204-D25-W25-L150-Z03 AEM90-AD1204-D26-W25-L180-Z03 AEM90-AD1204-D32-W32-L150-Z04
		ADMT 1606.. (For WLTR)	AEM90-AD1606-D25-W25-L150-Z02 AEM90-AD1606-D32-W32-L150-Z03
		ADMT 1606.. (For WLTR)	

Frezeleme Takımları / Milling Tools

Yüze Frezeler / Face Milling Tools

90°	AFM90-AD10T3	Uç / Insert	Takım Kodu / Tool Code
		ADMT 10T3.. (For WLTR)	AFM90-AD10T3-D040-A16-Z06-H AFM90-AD10T3-D050-A22-Z07-H

S Sistem Yüze Parmak Frezeler / S System End Mills

90°	AEM90-AN1607	Uç / Insert	Takım Kodu / Tool Code
		AN.X 1607.. (For TGTC)	AEM90-AN1607-D32-C25-L150-Z02 AEM90-AN1607-D40-C32-L150-Z03

Yüze Frezeler / Face Milling Tools

90°	AFM90-AN..	Uç / Insert	Takım Kodu / Tool Code
		ANGX 1105.. ANGX 150608 (For ZCC)	AFM90-AN11-D040-A16-Z04-H AFM90-AN1506-D050-A22-Z04-H AFM90-AN1506-D063-A22-Z05-H AFM90-AN1506-D080-A27-Z06-H AFM90-AN1506-D100-A32-Z08-H AFM90-AN1506-D125-B40-Z12 AFM90-AN1506-D160-C40-Z14

Yüze Frezeler / Face Milling Tools

90°	AFM90-AN1607	Uç / Insert	Takım Kodu / Tool Code
		AN.X 1607.. (For TGTC)	AFM90-AN1607-D050-A22-Z04-H AFM90-AN1607-D063-A22-Z06-H AFM90-AN1607-D080-A27-Z07-H AFM90-AN1607-D100-A32-Z08-H AFM90-AN1607-D125-B40-Z10

S Sistem Yüze Parmak Frezeler / S System End Mills

90°	AEM90-AN11	Uç / Insert	Takım Kodu / Tool Code
		ANGX 110508 (For ZCC)	AEM90-AN11-D22-W20-L150-Z02 AEM90-AN11-D25-W25-L150-Z02 AEM90-AN11-D25-C25-L200-Z02 AEM90-AN11-D26-W25-L150-Z02 AEM90-AN11-D28-W25-L150-Z02 AEM90-AN11-D32-W32-L150-Z03 AEM90-AN11-D32-C32-L200-Z03 AEM90-AN11-D40-W32-L150-Z04

S Sistem Yüze Parmak Frezeler / S System End Mills

90°	AEM90-A01236	Uç / Insert	Takım Kodu / Tool Code
		A0. 1236.. (For MTSBSH)	AEM90-A01236-D16-C16-L85-Z02-H AEM90-A01236-D16-W16-L150-Z02 AEM90-A01236-D20-C20-L100-Z02 AEM90-A01236-D25-C25-L115-Z02 AEM90-A01236-D25-W25-L150-Z03 AEM90-A01236-D32-W32-L150-Z04

S Sistem Yüze Parmak Frezeler / S System End Mills

90°	AEM90-AN1207	Uç / Insert	Takım Kodu / Tool Code
		ANKX 1207.. (For XTC-GSC)	AEM90-AN1207-D25-W25-L150-Z02 AEM90-AN1207-D32-W32-L150-Z03 AEM90-AN1207-D40-W32-L150-Z04

S Sistem Modüler Parmak Frezeler / S System Modular End Mills (Screw Type Tools)

90°	AEM90-A01236	Uç / Insert	Takım Kodu / Tool Code
		A0. 1236.. (For MTSBSH)	AEM90-A01236-D16-M08-L30-Z02 AEM90-A01236-D20-M10-L35-Z03

Yüze Frezeler / Face Milling Tools

90°	AFM90-AN..	Uç / Insert	Takım Kodu / Tool Code
		ANKX 1207.. (For XTC-GSC) ANKX 1607.. (For XTC-GSC)	AFM90-AN1207-D040-A16-Z04-H AFM90-AN1207-D050-A22-Z05-H AFM90-AN1207-D063-A22-Z06-H AFM90-AN1207-D063-A27-Z06-H AFM90-AN1607X-D050-A22-Z04-H AFM90-AN1607X-D063-A22-Z06-H AFM90-AN1607X-D080-A27-Z07-H

Yüze Frezeler / Face Milling Tools

90°	AFM90-A0..	Uç / Insert	Takım Kodu / Tool Code
		A0. 1236.. A0. 1848.. (For MTSBSH)	AFM90-A01236-D050-A22-Z05-H AFM90-A01848-D050-A22-Z05-H AFM90-A01848-D063-A22-Z06-H

Yüze Frezeler / Face Milling Tools

90°	AFM90-AN12	Uç / Insert	Takım Kodu / Tool Code
		ANKX 1205.. (For ISCR)	AFM90-AN12-D040-A16-Z04-H AFM90-AN12-D050-A22-Z05-H AFM90-AN12-D063-A27-Z06-H



S Sistem YüzeY Parmak Frezeler / S System End Mills

90°	AEM90-AP..	Uç / Insert	Takım Kodu / Tool Code
	APMT 0602.. (For KRLY)	APMT 0602.. (For KRLY)	AEM90-AP06-D10-C10-L120-Z02
			AEM90-AP06-D12-C12-L120-Z02
	APMT 0903.. (For KRLY)	APMT 0903.. (For KRLY)	AEM90-AP0903-D16-C16-L150-Z02
			AEM90-AP0903-D17-C16-L150-Z02
			AEM90-AP0903-D20-C20-L150-Z02
			AEM90-AP0903-D21-C20-L150-Z02
	APKT 09T3.. (For TGTC)	APKT 09T3.. (For TGTC)	AEM90-AP09-D16-C16-L100-Z02-H
			AEM90-AP09-D16-C15-L150-Z02
			AEM90-AP09-D16-W16-L150-Z02-H
			AEM90-AP09-D16-C16-L200-Z02-H
AEM90-AP09-D17-C16-L150-Z02			
AEM90-AP09-D17-C16-L180-Z02-H			
AEM90-AP09-D20-C20-L150-Z03-H			
AEM90-AP09-D20-C20-L200-Z03-H			
AEM90-AP09-D20-C20-L250-Z02-H			
AEM90-AP09-D21-C20-L150-Z03			
AEM90-AP09-D26-C25-L150-Z04			
AP. 1003.. (For ISO)	AP. 1003.. (For ISO)	AEM90-AP10-D12-W16-L100-Z01-H	
		AEM90-AP10-D12-W16-L150-Z01	
		AEM90-AP10-D14-W16-L100-Z01-H	
		AEM90-AP10-D14-W16-L150-Z01	
		AEM90-AP10-D16-C16-L100-Z02-H	
		AEM90-AP10-D16-C16-L120-Z02-H	
		AEM90-AP10-D16-C16-L150-Z02	
		AEM90-AP10-D16-C16-L150-Z02-H	
		AEM90-AP10-D16-W16-L150-Z02	
		AEM90-AP10-D16-C16-L200-Z02	
AEM90-AP10-D16-C16-L200-Z02-H			
AEM90-AP10-D16-C16-L250-Z02			
AEM90-AP10-D18-W16-L100-Z02-H			
AEM90-AP10-D18-W16-L150-Z02			
AEM90-AP10-D20-C20-L100-Z03-H			
AEM90-AP10-D20-W20-L100-Z03-H			
AEM90-AP10-D20-C20-L120-Z03-H			
AEM90-AP10-D20-C20-L150-Z03			
AEM90-AP10-D20-C20-L150-Z03-H			
AEM90-AP10-D20-W20-L150-Z03			
AEM90-AP10-D20-C20-L200-Z02			
AEM90-AP10-D20-C20-L200-Z03-H			
AEM90-AP10-D20-C20-L250-Z02			
AEM90-AP10-D20-C20-L250-Z02-H			
AEM90-AP10-D21-W20-L150-Z03			
AEM90-AP10-D22-W20-L100-Z03-H			
AEM90-AP10-D22-W20-L150-Z03			
AEM90-AP10-D23-W20-L150-Z03			
AEM90-AP10-D24-W20-L150-Z03			
AEM90-AP10-D25-W25-L100-Z04-H			
AEM90-AP10-D25-C25-L100-Z03-H			
AEM90-AP10-D25-W25-L100-Z03-H			
AEM90-AP10-D25-C25-L120-Z03-H			
AEM90-AP10-D25-C25-L150-Z03			
AEM90-AP10-D25-W25-L150-Z03			
AEM90-AP10-D25-C25-L200-Z02			
AEM90-AP10-D25-C25-L200-Z03			
AEM90-AP10-D25-C25-L250-Z02			
AEM90-AP10-D30-C25-L100-Z04-H			
AEM90-AP10-D30-C25-L120-Z04-H			
AEM90-AP10-D30-C25-L150-Z04			
AEM90-AP10-D32-C25-L100-Z04-H			
AEM90-AP10-D32-C25-L120-Z04-H			
AEM90-AP10-D32-C25-L150-Z04			
AEM90-AP10-D32-W25-L150-Z04			
AEM90-AP10-D32-W32-L150-Z04			
AEM90-AP10-D40-W32-L150-Z05			
AP. 1003.. (For DJT)	AP. 1003.. (For DJT)	AEM90-AP10D-D16-W16-L150-Z02	
		AEM90-AP10D-D20-W20-L150-Z03	
AP. 1003.. (For B.OKE)	AP. 1003.. (For B.OKE)	AEM90-AP100-D16-C15-L150-Z02	
		AEM90-AP100-D21-C20-L150-Z03	
		AEM90-AP100-D26-C25-L150-Z04	
AP. 1003.. (For SMTM)	AP. 1003.. (For SMTM)	AEM90-AP10S-D16-W16-L150-Z02	
		AEM90-AP10S-D20-W20-L150-Z02	
		AEM90-AP10S-D25-W25-L150-Z03	

S Sistem YüzeY Parmak Frezeler / S System End Mills

90°	AEM90-AP..	Uç / Insert	Takım Kodu / Tool Code
	AP. 11T3.. (For ZCC)	AP. 11T3.. (For ZCC)	AEM90-AP11-D16-C16-L150-Z02
			AEM90-AP11-D16-C16-L150-Z02-H
			AEM90-AP11-D16-W16-L150-Z02
			AEM90-AP11-D16-W16-L150-Z02-H
			AEM90-AP11-D16-C16-L200-Z02
			AEM90-AP11-D17-C16-L150-Z02
			AEM90-AP11-D17-C16-L200-Z02
			AEM90-AP11-D20-C20-L150-Z03
			AEM90-AP11-D20-W20-L150-Z03
			AEM90-AP11-D20-W20-L150-Z03-H
APMT 1135.. (For ACHTK)	APMT 1135.. (For ACHTK)	APMT 1135.. (For ACHTK)	AEM90-AP11-D20-C20-L200-Z03
			AEM90-AP11-D21-C20-L150-Z03
			AEM90-AP11-D21-W20-L150-Z03
			AEM90-AP11-D21-W20-L150-Z03-H
			AEM90-AP11-D21-C20-L200-Z03
			AEM90-AP11-D25-C25-L150-Z03
			AEM90-AP11-D25-W25-L150-Z03
			AEM90-AP11-D25-W25-L150-Z03-H
			AEM90-AP11-D26-C25-L150-Z03
			AEM90-AP11-D26-C24-L150-Z03
AEM90-AP11-D32-W25-L150-Z04			
AEM90-AP11-D32-W32-L150-Z03-H			
AEM90-AP11-D32-W32-L150-Z04			
APMT 1135.. (For ACHTK)	APMT 1135.. (For ACHTK)	APMT 1135.. (For ACHTK)	AEM90-AP1135A-D14-C16-L150-Z01
			AEM90-AP1135A-D16-C16-L150-Z02
			AEM90-AP1135A-D16-C16-L200-Z02
			AEM90-AP1135A-D16-C16-L250-Z02
			AEM90-AP1135A-D17-C16-L180-Z02
			AEM90-AP1135A-D20-C20-L150-Z03
			AEM90-AP1135A-D20-C20-L200-Z02
			AEM90-AP1135A-D21-C20-L180-Z02
			AEM90-AP1135A-D25-C25-L200-Z03
			AEM90-AP1135A-D26-C25-L250-Z02
AEM90-AP1135A-D33-C32-L250-Z02			
APMT 1135.. (For B.OKE)	APMT 1135.. (For B.OKE)	APMT 1135.. (For B.OKE)	AEM90-AP110-D16-C15-L150-Z02
			AEM90-AP110-D21-C20-L150-Z03
			AEM90-AP110-D26-C25-L150-Z04
APKT 1135.. (For XTC-GSC)	APKT 1135.. (For XTC-GSC)	APKT 1135.. (For XTC-GSC)	AEM90-AP110-D33-C32-L200-Z05
			AEM90-APK11G-D16-W16-L150-Z02
			AEM90-APK11G-D20-W20-L150-Z03
AP. 1135.. (For XTC-GSC)	AP. 1135.. (For XTC-GSC)	AP. 1135.. (For XTC-GSC)	AEM90-APK11G-D25-W25-L150-Z03
			AEM90-AP1135-D16-W16-L150-Z02
AP. 1204.. (For TGTC)	AP. 1204.. (For TGTC)	AP. 1204.. (For TGTC)	AEM90-AP1135-D20-W20-L150-Z03
			AEM90-AP1204-D20-C20-L150-Z02
AP. 1604.. (For ISO)	AP. 1604.. (For ISO)	AP. 1604.. (For ISO)	AEM90-AP1204-D21-C20-L150-Z02
			AEM90-AP1204-D21-C20-L200-Z02
			AEM90-AP1204-D25-C25-L150-Z03
			AEM90-AP1204-D26-C25-L250-Z02
			AEM90-AP1204-D32-C25-L150-Z03
			AEM90-AP16-D25-C20-L100-Z02
			AEM90-AP16-D25-W25-L100-Z02-H
			AEM90-AP16-D25-W25-L150-Z02
			AEM90-AP16-D25-C25-L250-Z02
			AEM90-AP16-D28-W25-L100-Z03-H
AEM90-AP16-D28-W25-L150-Z03			
AEM90-AP16-D30-W25-L110-Z03-H			
AEM90-AP16-D30-W25-L150-Z02			
AEM90-AP16-D30-W25-L150-Z03			
AEM90-AP16-D32-W32-L110-Z03-H			
AEM90-AP16-D32-C32-L150-Z03			
AEM90-AP16-D32-W32-L150-Z03			
AEM90-AP16-D32-W32-L150-Z03-H			
AEM90-AP16-D32-C25-L200-Z03-H			
AEM90-AP16-D32-C32-L250-Z02			
AEM90-AP16-D32-C32-L250-Z03			
AEM90-AP16-D35-W32-L150-Z03			
AEM90-AP16-D36-W32-L150-Z03			
AEM90-AP16-D40-W32-L110-Z04-H			
AEM90-AP16-D40-C32-L150-Z04			
AEM90-AP16-D40-W32-L150-Z04			
AEM90-AP16-D40-C32-L250-Z02			
AEM90-AP16-D40-C32-L250-Z04			

Frezeleme Takımları / Milling Tools

S Sistem Yüzey Parmak Frezeler / S System End Mills

90°	AEM90-AP..	Uç / Insert	Takım Kodu / Tool Code
	AP. 1604.. (For DJT)		AEM90-AP160J-D25-W25-L150-Z02
			AEM90-AP160J-D25-C25-L200-Z02
			AEM90-AP160J-D32-W32-L150-Z03
			AEM90-AP160J-D32-C32-L180-Z03
	AP. 1604.. (For LMN)		AEM90-AP16L-D25-C25-L120-Z02-H
			AEM90-AP16L-D25-C25-L150-Z02
			AEM90-AP16L-D25-C25-L200-Z02
			AEM90-AP16L-D25-C25-L250-Z02
	AP. 1604.. (For PLBT)		AEM90-AP16L-D32-C32-L120-Z03-H
			AEM90-AP16L-D32-C32-L150-Z03
			AEM90-AP16L-D32-C32-L200-Z03
			AEM90-AP16L-D32-C32-L250-Z03
AP. 1604.. (For TGTC)		AEM90-AP16L-D40-C32-L120-Z04-H	
		AEM90-AP16L-D40-C32-L150-Z04	
		AEM90-AP16L-D40-C32-L200-Z04	
		AEM90-AP16L-D40-C32-L250-Z04	
AP. 1604.. (For PLBT)		AEM90-AP16P-D25-W25-L100-Z02-H	
		AEM90-AP16P-D25-W25-L150-Z02	
		AEM90-AP16P-D32-W32-L150-Z03	
		AEM90-AP16P-D32-C32-L250-Z02	
AP. 1705.. (For TGTC)		AEM90-AP1705-D25-C25-L120-Z02	
		AEM90-AP1705-D26-C25-L200-Z02	
		AEM90-AP1705-D26-C25-L250-Z02	
		AEM90-AP1705-D26-C25-L300-Z02	
AP. 1705.. (For TGTC)		AEM90-AP1705-D28-W25-L075-Z02	
		AEM90-AP1705-D32-C25-L150-Z03	
		AEM90-AP1705-D33-C32-L250-Z03	
		AEM90-AP1705-D33-C32-L300-Z02	

S Sistem Modüler Parmak Frezeler / S System Modular End Mills (Screw Type Tools)

90°	AEM90-AP..	Uç / Insert	Takım Kodu / Tool Code
	AP. 1003.. (For ISO)		AEM90-AP10-D16-M08-L30-Z02-H
			AEM90-AP10-D20-M10-L30-Z03-H
			AEM90-AP10-D25-M12-L35-Z03-H
			AEM90-AP10-D32-M16-L35-Z04-H
			AEM90-AP10-D40-M16-L43-Z05-H
			AEM90-AP10-D42-M16-L43-Z05-H
	AP. 1003.. (For DJT)		AEM90-AP10D-D16-M08-L30-Z02-H
			AEM90-AP10D-D20-M10-L30-Z03-H
	AP. 11T3.. (For ZCC)		AEM90-AP11-D25-M12-L35-Z03-H
			AEM90-AP11-D32-M16-L35-Z04-H
	AP. 1604.. (For ISO)		AEM90-AP11-D40-M16-L43-Z05-H
			AEM90-AP16-D25-M12-L43-Z02-H
AP. 1604.. (For DJT)		AEM90-AP16-D32-M16-L43-Z03-H	
		AEM90-AP16-D40-M16-L43-Z04-H	
AP. 1604.. (For LMNA)		AEM90-AP16-D42-M16-L43-Z04	
		AEM90-AP16D-D25-M12-L43-Z02-H	
AP. 1604.. (For DJT)		AEM90-AP16D-D32-M16-L43-Z03-H	
		AEM90-AP16D-D40-M16-L43-Z04-H	
AP. 1604.. (For LMNA)		AEM90-AP16L-D25-M12-L43-Z02-H	
		AEM90-AP16L-D32-M16-L43-Z03-H	
AP. 1604.. (For LMNA)		AEM90-AP16L-D40-M16-L43-Z04-H	

S Sistem Helis Frezeler / S System Helix End Mills

90°	AHM90-AP10	Uç / Insert	Takım Kodu / Tool Code
	AP. 1003.. (For ISO)		AHM90-AP10-D20-W20-L087-Z04
			AHM90-AP10-D20-W20-L087-Z0206
			AHM90-AP10-D25-W25-L105-Z0208-H
			AHM90-AP10-D32-W32-L115-Z0315-H
			AHM90-AP10-D40-W32-L130-Z0318-H

Yüzey Frezeler / Face Milling Tools

75°	AFM75-AP16	Uç / Insert	Takım Kodu / Tool Code
	AP. 1604.. (For ISO)		AFM75-AP16-D063-A22-Z04-H
			AFM75-AP16-D080-A27-Z05-H
			AFM75-AP16-D100-A32-Z06-H
			AFM75-AP16-D125-B40-Z07

Yüzey Frezeler / Face Milling Tools

90°	AFM90-AP..	Uç / Insert	Takım Kodu / Tool Code
	AP. 1003.. (For ISO)		AFM90-AP10-D040-A16-Z05-H
			AFM90-AP10-D050-A22-Z06-H
			AFM90-AP10-D063-A22-Z07-H
			AFM90-AP10-D080-A27-Z08-H
	AP. 1604.. (For ISO)		AFM90-AP10-D100-A32-Z09-H
			AFM90-AP16-D040-A16-Z04-H
			AFM90-AP16-D050-A22-Z05-H
			AFM90-AP16-D063-A22-Z06-H
	AP. 1604.. (For ISO)		AFM90-AP16-D080-A27-Z07-H
			AFM90-AP16-D100-A32-Z08-H
			AFM90-AP16-D125-B40-Z09
			AFM90-AP16-D160-C40-Z10
AP. 1604. (For DJT)		AFM90-AP16-D200-C60-Z12	
		AFM90-AP16D-D050-A22-Z05-H	
AP. 1604. (For LMNA)		AFM90-AP16D-D063-A22-Z06-H	
		AFM90-AP16D-D080-A27-Z07-H	
AP. 1604.. (For PLBT)		AFM90-AP16D-D100-A32-Z08-H	
		AFM90-AP16D-D125-B40-Z09	
AP. 1604.. (For ACHTK)		AFM90-AP16D-D160-C40-Z10	
		AFM90-AP16D-D200-C60-Z12	

Yüzey Frezeler / Face Milling Tools

90°	AFM90-AP1705	Uç / Insert	Takım Kodu / Tool Code
	AP. 1705.. (For TGTC-LMNA)		AFM90-AP1705-D050-A22-Z05-H
			AFM90-AP1705-D063-A22-Z06-H
			AFM90-AP1705-D080-A27-Z07-H
			AFM90-AP1705-D100-A32-Z08-H

S Sistem Modüler Parmak Frezeler / S System Modular End Mills (Screw Type Tools)

90°	AEM90-AX..	Uç / Insert	Takım Kodu / Tool Code
	AP. 1705.. (For SMTM)		AEM90-AX1235-D16-M08-L30-Z02-H
			AEM90-AX1235-D20-M10-L30-Z03-H
			AEM90-AX1235-D25-M12-L35-Z04-H
			AEM90-AX1705-D25-M12-L43-Z02-H
AP. 1705.. (For SMTM)		AEM90-AX1705-D32-M16-L43-Z02-H	



Frezeleme Takımları / Milling Tools

S Sistem YüzeY Parmak Frezeler / S System End Mills

90°	AEM90-AX..	Uç / Insert	Takım Kodu / Tool Code
	AX.T 0602.. (For TGTC)		AEM90-AX0602-D10-C09-L120-Z02
			AEM90-AX0602-D10-C10-L080-Z02
			AEM90-AX0602-D10-C10-L120-Z02
			AEM90-AX0602-D12-C11-L120-Z02
			AEM90-AX0602-D12-C12-L080-Z02
			AEM90-AX0602-D12-C12-L120-Z02
			AEM90-AX0602-D14-C12-L120-Z03
			AEM90-AX0602-D16-W16-L120-Z04-H
			AEM90-AX0602-D16-W16-L150-Z04-H
			AEM90-AX0602-D20-W20-L120-Z05-H
	AEM90-AX0602-D20-W20-L150-Z05-H		
	AX.T 0903.. (For TGTC)		AEM90-AX0903-D16-C16-L120-Z02
			AEM90-AX0903-D16-C16-L180-Z02
			AEM90-AX0903-D17-C16-L120-Z02
			AEM90-AX0903-D17-C16-L180-Z02
			AEM90-AX0903-D20-C20-L120-Z03
			AEM90-AX0903-D20-C20-L200-Z02
			AEM90-AX0903-D21-C20-L120-Z03
			AEM90-AX0903-D21-C20-L200-Z02
			AEM90-AX0903-D25-C25-L150-Z03
AEM90-AX0903-D25-C25-L250-Z02			
AEM90-AX0903-D26-C25-L150-Z03			

S Sistem YüzeY Parmak Frezeler / S System End Mills

90°	AEM90-AZ11..	Uç / Insert	Takım Kodu / Tool Code
	AZGT 1135.. (For ZCC)		AEM90-AZ11-D12-W16-L90-Z01
			AEM90-AZ11-D16-C16-L200-Z02
			AEM90-AZ11-D16-W15-L170-Z02
			AEM90-AZ11-D16-W16-L100-Z02
			AEM90-AZ11-D16-W16-L150-Z02
			AEM90-AZ11-D17-C16-L150-Z02
			AEM90-AZ11-D17-C16-L180-Z02
			AEM90-AZ11-D17-W16-L100-Z02
			AEM90-AZ11-D20-C20-L200-Z03
			AEM90-AZ11-D20-W19-L170-Z03
			AEM90-AZ11-D20-W20-L110-Z02
			AEM90-AZ11-D21-C20-L150-Z03
			AEM90-AZ11-D21-C20-L180-Z03
			AEM90-AZ11-D21-W20-L110-Z03
			AEM90-AZ11-D25-C24-L180-Z04
			AEM90-AZ11-D25-W25-L110-Z04
			AEM90-AZ11-D26-C25-L250-Z02
			AEM90-AZ11-D26-W25-L120-Z03
			AEM90-AZ11-D26-W25-L120-Z04
			AEM90-AZ11-D28-C25-L250-Z02
AEM90-AZ11-D33-W32-L130-Z04			

S Sistem YüzeY Parmak Frezeler / S System End Mills

90°	AEM90-AX..	Uç / Insert	Takım Kodu / Tool Code
	AX.T 1235.. (For SMTM)		AEM90-AX1235-D16-C14-L120-Z02-H
			AEM90-AX1235-D16-C15-L145-Z02-H
			AEM90-AX1235-D16-C16-L100-Z02-H
			AEM90-AX1235-D16-C16-L140-Z02-H
			AEM90-AX1235-D16-C16-L145-Z02-H
			AEM90-AX1235-D16-C16-L150-Z02
			AEM90-AX1235-D20-C19-L150-Z02-H
			AEM90-AX1235-D20-C20-L110-Z03-H
			AEM90-AX1235-D20-C20-L150-Z02
			AEM90-AX1235-D20-C20-L150-Z02-H
			AEM90-AX1235-D20-C20-L150-Z03
			AEM90-AX1235-D25-C20-L120-Z04-H
			AEM90-AX1235-D25-C20-L150-Z04-H
			AEM90-AX1235-D25-C24-L170-Z02-H
			AEM90-AX1235-D25-C25-L120-Z04-H
			AEM90-AX1235-D25-C25-L150-Z03
			AEM90-AX1235-D25-C25-L170-Z02-H
			AEM90-AX1235-D25-W25-L100-Z04-H
	AEM90-AX1235-D32-C32-L130-Z05-H		
	AEM90-AX1235-D32-C32-L180-Z02-H		
AX.T 1705.. (For SMTM)		AEM90-AX1705-D25-C25-L150-Z02	
		AEM90-AX1705-D28-W25-L115-Z02-H	
		AEM90-AX1705-D32-C32-L150-Z03	
		AEM90-AX1705-D32-C32-L180-Z02-H	

S Sistem YüzeY Parmak Frezeler / S System End Mills

90°	AEM90-BD..	Uç / Insert	Takım Kodu / Tool Code
	BDMT 0703.. (For KYCR)		AEM90-BD0703-D12-C11-L120-Z02
			AEM90-BD0703-D12-C12-L120-Z02
			AEM90-BD11T3-D16-C15-L180-Z02
			AEM90-BD11T3-D16-C16-L100-Z02-H
			AEM90-BD11T3-D16-W16-L100-Z02-H
			AEM90-BD11T3-D16-W16-L150-Z02
			AEM90-BD11T3-D17-W16-L150-Z02
			AEM90-BD11T3-D17-C16-L180-Z02
			AEM90-BD11T3-D18-W16-L100-Z02
			AEM90-BD11T3-D18-W16-L100-Z02-H
	AEM90-BD11T3-D20-W20-L100-Z02-H		
	AEM90-BD11T3-D20-W20-L100-Z03-H		
	AEM90-BD11T3-D20-C20-L110-Z03-H		
	AEM90-BD11T3-D20-W20-L150-Z02		
	AEM90-BD11T3-D20-W20-L150-Z03		
	AEM90-BD11T3-D21-W20-L150-Z03		
	AEM90-BD11T3-D21-C20-L200-Z02		
	AEM90-BD11T3-D22-W20-L090-Z02-H		
	AEM90-BD11T3-D25-W25-L100-Z03-H		
	AEM90-BD11T3-D25-C25-L120-Z03-H		
AEM90-BD11T3-D25-W25-L150-Z03			
AEM90-BD11T3-D26-W25-L150-Z03			
AEM90-BD11T3-D26-C25-L250-Z02			
AEM90-BD11T3-D32-W32-L110-Z04-H			
AEM90-BD11T3-D32-C32-L130-Z04-H			
AEM90-BD11T3-D32-W32-L150-Z04			
AEM90-BD11T3-D40-W32-L110-Z04-H			
BDMT 11T3.. (For KYCR)		AEM90-BD1704-D25-W25-L100-Z02-H	
		AEM90-BD1704-D25-W25-L150-Z02	
		AEM90-BD1704-D32-W32-L110-Z03-H	
		AEM90-BD1704-D32-W32-L150-Z03	
		AEM90-BD1704-D40-W32-L110-Z04-H	
		AEM90-BD1704-D40-W32-L150-Z04	

YüzeY Frezeler / Face Milling Tools

90°	AFM90-AX1705	Uç / Insert	Takım Kodu / Tool Code
	AX.T 1235.. (For SMTM)		AFM90-AX1235-D040-A16-Z06-H
			AFM90-AX1235-D050-A22-Z07-H
			AFM90-AX1235-D063-A22-Z08-H
			AFM90-AX1235-D080-A27-Z10-H
			AFM90-AX1705-D040-A16-Z04-H
	AX.T 1705.. (For SMTM)		AFM90-AX1705-D050-A22-Z05-H
			AFM90-AX1705-D063-A22-Z06-H
			AFM90-AX1705-D080-A27-Z07-H
			AFM90-AX1705-D100-A32-Z08-H

Frezeleme Takımları / Milling Tools

Yüzey Frezeler / Face Milling Tools

90°	AFM90-BD1704	Uç / Insert	Takım Kodu / Tool Code
		BDMT 1704.. (For KYCR)	AFM90-BD1704-D050-A22-Z05-H AFM90-BD1704-D063-A22-Z06-H AFM90-BD1704-D080-A27-Z07-H

S Sistem Yüzey Parmak Frezeler / S System End Mills

90°	AEM90-LN08	Uç / Insert	Takım Kodu / Tool Code
		LNMT 0804.. (For ISCR)	AEM90-LN08-D16-W16-L100-Z02-H AEM90-LN08-D20-W20-L100-Z03-H AEM90-LN08-D25-W25-L100-Z03-H AEM90-LN08-D32-W32-L110-Z05-H

S Sistem Modüler Parmak Frezeler / S System Modular End Mills (Screw Type Tools)

90°	AEM90-DC..	Uç / Insert	Takım Kodu / Tool Code
		DC.T 0702. (For ISO)	AEM90-DC07-D20-M10-L30-Z02-H AEM90-DC07-D25-M12-L35-Z03-H AEM90-DC07-D32-M16-L43-Z04-H AEM90-DC07-D40-M16-L43-Z05-H
		DC.T 11T3.. (For ISO)	AEM90-DC11-D32-M16-L43-Z03-H-F AEM90-DC11-D40-M16-L43-Z03-H-F

Yüzey Frezeler / Face Milling Tools

90°	AFM90-LN..	Uç / Insert	Takım Kodu / Tool Code
		LNMT 1106.. (For ISCR)	AFM90-LN1106-D050-A22-Z05 AFM90-LN1106-D063-A22-Z06 AFM90-LN1106-D080-A27-Z08 AFM90-LN1106-D100-A32-Z09 AFM90-LN1106-D125-B40-Z10
		LNMT 1306.. (For ISCR)	AFM90-LN1306-D040-A16-Z04-H AFM90-LN1306-D050-A22-Z05-H AFM90-LN1306-D063-A22-Z06-H AFM90-LN1306-D080-A27-Z07-H AFM90-LN1306-D100-A32-Z08-H
		LNMT 1506.. (For ISCR)	AFM90-LN1506-D040-A16-Z04 AFM90-LN1506-D040-A16-Z04 AFM90-LN1506-D050-A22-Z05 AFM90-LN1506-D063-A22-Z06 AFM90-LN1506-D080-A27-Z07
		LNMT 1607.. (For ISCR)	AFM90-LN1607-D050-A22-Z03-H AFM90-LN1607-D063-A22-Z04-H AFM90-LN1607-D080-A27-Z05-H AFM90-LN1607-D100-A32-Z06-H

S Sistem Yüzey Parmak Frezeler / S System End Mills

90°	AEM90-ED..	Uç / Insert	Takım Kodu / Tool Code
		EDPT 10T3.. (For KNMTL)	AEM90-ED10T3-D16-W16-L120-Z02 AEM90-ED10T3-D20-W20-L120-Z02
		EDPT 1404.. (For KNMTL)	AEM90-ED1404-D20-W20-L150-Z02 AEM90-ED1404-D25-W25-L150-Z02 AEM90-ED1404-D30-C25-L150-Z03

Yüzey Frezeler / Face Milling Tools

45°	AFM45-HN0905	Uç / Insert	Takım Kodu / Tool Code
		HN.. 0905.. (For WDA)	AFM45-HN0905-D050-A22-Z05-H AFM45-HN0905-D063-A22-Z06-H AFM45-HN0905-D080-A27-Z07-H AFM45-HN0905-D125-B40-Z10 AFM45-HN0905-D160-C40-Z12 AFM45L-HN0905-D160-C40-Z12 AFM45L-HN0905-D200-C60-Z16

S Sistem Yüzey Parmak Frezeler / S System End Mills

90°	AEM90-LN1106	Uç / Insert	Takım Kodu / Tool Code
		LNMT 1106.. (For XTC-GSC)	AEM90-LN1106-D25-W25-L150-Z03 AEM90-LN1106-D32-W32-L150-Z04 AEM90-LN1106-D40-W32-L150-Z05

Yüzey Frezeler / Face Milling Tools

45°	AFM45C-HN0905	Uç / Insert	Takım Kodu / Tool Code
		HN.. 0905.. (For WDA-KNMTL)	AFM45C-HN0905-D063-A22-Z07 AFM45C-HN0905-D080-A27-Z09 AFM45C-HN0905-D100-A32-Z11 AFM45C-HN0905-D125-B40-Z13 AFM45CL-HN0905-D125-B40-Z10 AFM45C-HN0905-D160-C40-Z15

Yüzey Frezeler / Face Milling Tools

90°	AFM90-LN1506X	Uç / Insert	Takım Kodu / Tool Code
		LNMT 1506.. (For XTC-GSC)	AFM90-LN1506X-D063-A22-Z06 AFM90-LN1506X-D080-A27-Z07 AFM90-LN1506X-D100-A32-Z08

Yüzey Frezeler / Face Milling Tools

90°	AFM90-LN1306W	Uç / Insert	Takım Kodu / Tool Code
		LNHU 1306.. (For WLTR)	AFM90-LN1306W-D050-A22-Z05-H AFM90-LN1306W-D063-A22-Z06-H AFM90-LN1306W-D080-A27-Z07-H

Yüzey Frezeler / Face Milling Tools

45°	AFM45-NN2007	Uç / Insert	Takım Kodu / Tool Code
		NNMU 2007.. (For MTSBSh)	AFM45-NN2007-D100-A32-Z07-H AFM45-NN2007-D125-B40-Z08 AFM45-NN2007-D160-C40-Z10



Frezeleme Takımları / Milling Tools

S Sistem Yüzey Parmak Frezeler / S System End Mills			Yüzey Frezeler / Face Milling Tools				
90°	AEM90-LN15T6	Uç / Insert LNGU 15T6.. (For KNMTL)	Takım Kodu / Tool Code AEM90-LN15T6-D25-W25-L150-Z02-H AEM90-LN15T6-D32-W32-L150-Z03-H AEM90-LN15T6-D40-W32-L150-Z03-H	43°	AFM43-0F05T3	Uç / Insert OF. 05T3.. (For ISO)	Takım Kodu / Tool Code AFM43-0F05T3-D050-A22-Z05-H AFM43-0F05T3-D063-A22-Z06-H AFM43-0F05T3-D080-A27-Z07-H AFM43-0F05T3-D125-B40-Z09
Yüzey Frezeler / Face Milling Tools			Yüzey Frezeler / Face Milling Tools				
90°	AFM90-LN15T6	Uç / Insert LNGU 15T6.. (For KNMTL)	Takım Kodu / Tool Code AFM90-LN15T6-D050-A22-Z05-H AFM90-LN15T6-D063-A22-Z06-H AFM90-LN15T6-D080-A27-Z07-H	43°	AFM43C-0F07	Uç / Insert OF. 0704.. (For ISO)	Takım Kodu / Tool Code AFM43C-0F07-D063-A22-Z04 AFM43C-0F07-D080-A27-Z05 AFM43C-0F07-D100-A32-Z06 AFM43C-0F07-D125-B40-Z08 AFM43C-0F07-D160-C40-Z09
Yüzey Frezeler / Face Milling Tools			Yüzey Frezeler / Face Milling Tools				
90°	AFM90-LN1307	Uç / Insert LNGX 1307.. (For WLTR)	Takım Kodu / Tool Code AFM90-LN1307-D050-A22-Z04-H AFM90-LN1307-D063-A22-Z06-H AFM90-LN1307-D080-A27-Z07-H AFM90-LN1307-D100-A32-Z08-H	43°	AFM43-0N0604	Uç / Insert ON. 0604.. (For ZCC)	Takım Kodu / Tool Code AFM43-0N0604-D050-A22-Z05-H AFM43-0N0604-D063-A22-Z06-H AFM43-0N0604-D080-A27-Z07-H AFM43-0N0604-D100-A32-Z08-H AFM43-0N0604-D125-B40-Z09
Yüzey Frezeler / Face Milling Tools			Yüzey Frezeler / Face Milling Tools				
90°	AFM90-LN15Z	Uç / Insert LNKT 1506.. (For ZCC)	Takım Kodu / Tool Code AFM90-LN15Z-D050-A22-Z04 AFM90-LN15Z-D063-A22-Z05 AFM90-LN15Z-D080-A27-Z06 AFM90-LN15Z-D100-A32-Z07 AFM90-LN15Z-D125-B40-Z08	45°	AFM45-0N0806	Uç / Insert ON. 0806.. (For ISO)	Takım Kodu / Tool Code AFM45-0N0806-D063-A22-Z05-H AFM45-0N0806-D080-A27-Z06-H AFM45-0N0806-D100-A32-Z07-H AFM45-0N0806-D125-B40-Z08 AFM45-0N0806-D160-C40-Z10 AFM45-0N0806-D200-C60-Z12 AFM45-0N0806-D315-D60-Z16
Yüzey Frezeler / Face Milling Tools			Yüzey Frezeler / Face Milling Tools				
43°	AFM43-0D0504	Uç / Insert OD. 0504.. (For WLTR)	Takım Kodu / Tool Code AFM43-0D0504-D040-A16-Z04-H AFM43-0D0504-D050-A22-Z05-H AFM43-0D0504-D063-A22-Z06-H AFM43-0D0504-D080-A27-Z07-H AFM43-0D0504-D100-A32-Z08-H	44°	AFM44-0N0606	Uç / Insert ONHX 0606.. (For PLBT)	Takım Kodu / Tool Code AFM44-0N0606-D063-A22-Z06-H AFM44-0N0606-D080-A27-Z08-H AFM44-0N0606-D100-A32-Z10-H
Yüzey Frezeler / Face Milling Tools			Yüzey Frezeler / Face Milling Tools				
43°	AFM43C-0D0605	Uç / Insert OD. 0605.. (For WLTR-LMNA)	Takım Kodu / Tool Code AFM43C-0D0605-D080-A27-Z06-H AFM43C-0D0605-D100-A32-Z07-H AFM43C-0D0605-D125-B40-Z08	66°	AFM66-PN0905	Uç / Insert PNMU 0905.. (For KYCR)	Takım Kodu / Tool Code AFM66-PN0905-D050-A22-Z05 AFM66-PN0905-D063-A22-Z06 AFM66-PN0905-D080-A27-Z08 AFM66-PN0905-D100-A32-Z10 AFM66-PN0905-D125-B40-Z12

Frezeleme Takımları / Milling Tools

Yüze Frezeler / Face Milling Tools

67°	AFM67-PN1105	Uç / Insert	Takım Kodu / Tool Code
		PNEG 1105.. (For ZCC)	AFM67-PN1105-D050-A22-Z05 AFM67-PN1105-D063-A22-Z06 AFM67-PN1105-D080-A27-Z08 AFM67-PN1105-D100-B32-Z10 AFM67-PN1105-D125-B40-Z12 AFM67-PN1105-D160-C40-Z14

Yüze Frezeler / Face Milling Tools

90°	AFM90-R290.12	Uç / Insert	Takım Kodu / Tool Code
		R290-12T3.. (For SNDVK)	AFM90-R290.12-D050-A22-Z04-H AFM90-R290.12-D063-A22-Z05-H AFM90-R290.12-D080-A27-Z07-H AFM90-R290.12-D100-A32-Z09-H AFM90-R290.12-D125-B40-Z11

Yüze Frezeler / Face Milling Tools

90°	AFM90-R390..	Uç / Insert	Takım Kodu / Tool Code
		R390-11T3.. (For SNDVK)	AFM90-R390.11-D040-A16-Z05-H AFM90-R390.11-D050-A22-Z06-H AFM90-R390.11-D063-A22-Z07-H AFM90-R390.11-D080-A27-Z09-H
		R390-1704.. (For SNDVK)	AFM90-R390.17-D040-A16-Z04-H AFM90-R390.17-D050-A22-Z05-H AFM90-R390.17-D063-A22-Z06-H AFM90-R390.17-D080-A27-Z07-H AFM90-R390.17-D100-A32-Z08-H AFM90-R390.17-D125-B40-Z09
		R390-1806.. (For SNDVK)	AFM90-R390.18-D050-A22-Z04-H AFM90-R390.18-D063-A22-Z05-H AFM90-R390.18-D080-A27-Z06-H AFM90-R390.18-D100-A32-Z07-H AFM90-R390.18-D125-B40-Z08

S Sistem Yüze Parmak Frezeler / S System End Mills

90°	AEM90-R390..	Uç / Insert	Takım Kodu / Tool Code
		R390-11T3.. (For SNDVK)	AEM90-R390.11-D16-W16-L100-Z02-H AEM90-R390.11-D16-W16-L150-Z02 AEM90-R390.11-D16-W16-L150-Z02-H AEM90-R390.11-D20-W20-L090-Z02-H AEM90-R390.11-D20-W20-L100-Z03-H AEM90-R390.11-D20-W20-L150-Z03 AEM90-R390.11-D20-W20-L150-Z03-H AEM90-R390.11-D20-C20-L150-Z03 AEM90-R390.11-D22-W20-L090-Z02-H AEM90-R390.11-D25-C20-L150-Z03 AEM90-R390.11-D25-W25-L100-Z03-H AEM90-R390.11-D25-W25-L150-Z03 AEM90-R390.11-D25-W25-L150-Z03-H AEM90-R390.11-D30-W25-L150-Z04-H AEM90-R390.11-D32-C25-L200-Z03 AEM90-R390.11-D32-W32-L150-Z05-H
		R390-1704.. (For SNDVK)	AEM90-R390.17-D25-W25-L150-Z02 AEM90-R390.17-D25-W25-L150-Z02-H AEM90-R390.17-D30-W25-L150-Z03 AEM90-R390.17-D30-W25-L150-Z03-H AEM90-R390.17-D32-W32-L150-Z03-H
		R390-1806..	AEM90-R390.18-D32-C32-L150-Z03

S Sistem Yüze Parmak Frezeler / S System End Mills

90°	AEM90-RT..	Uç / Insert	Takım Kodu / Tool Code
		RT 0702.. (For SFTY)	AEM90-RT07-D10-W10-L120-Z02 AEM90-RT07-D12-C12-L120-Z02 AEM90-RT07-D12-W12-L120-Z02 AEM90-RT07-D14-W12-L120-Z02
		RT 1003.. (For SFTY)	AEM90-RT10-D16-C15-L160-Z02 AEM90-RT10-D16-W16-L120-Z02-H AEM90-RT10-D16-W16-L150-Z02 AEM90-RT10-D16-C16-L200-Z02 AEM90-RT10-D17-W16-L160-Z02 AEM90-RT10-D17-C16-L200-Z02 AEM90-RT10-D18-W16-L120-Z02-H AEM90-RT10-D20-C19-L200-Z03 AEM90-RT10-D20-C20-L110-Z03 AEM90-RT10-D20-W20-L120-Z03-H AEM90-RT10-D20-W20-L150-Z03 AEM90-RT10-D20-C20-L200-Z03 AEM90-RT10-D21-W20-L200-Z03 AEM90-RT10-D22-W20-L120-Z03-H AEM90-RT10-D22-C20-L150-Z03 AEM90-RT10-D22-C20-L200-Z03 AEM90-RT10-D25-W25-L120-Z04-H AEM90-RT10-D25-W25-L150-Z04 AEM90-RT10-D25-C25-L200-Z04 AEM90-RT10-D26-C25-L250-Z04 AEM90-RT10-D32-W32-L120-Z05-H AEM90-RT10-D32-W32-L150-Z05 AEM90-RT10-D32-C32-L200-Z05 AEM90-RT10-D33-C32-L250-Z04
		RT 1304.. (For SFTY)	AEM90-RT13-D32-C32-L250-Z04
		RT 1604.. (For SFTY)	AEM90-RT16-D25-W25-L120-Z02-H AEM90-RT16-D25-W25-L150-Z02 AEM90-RT16-D25-C25-L200-Z02 AEM90-RT16-D32-W32-L120-Z03-H AEM90-RT16-D32-W32-L150-Z03 AEM90-RT16-D32-C32-L200-Z03 AEM90-RT16-D32-C32-L250-Z03 AEM90-RT16-D32-C32-L270-Z03 AEM90-RT16-D40-W32-L120-Z04-H AEM90-RT16-D40-W32-L150-Z04 AEM90-RT16-D40-C32-L200-Z04

S Sistem Modüler Parmak Frezeler / S System Modular End Mills (Screw Type Tools)

90°	AEM90-R390.11	Uç / Insert	Takım Kodu / Tool Code
		R390-11T3 (For SNDVK)	AEM90-R390.11-D16-M08-L30-Z02-H AEM90-R390.11-D20-M10-L30-Z03-H AEM90-R390.11-D25-M12-L35-Z03-H AEM90-R390.11-D32-M16-L43-Z04-H

S Sistem Modüler Parmak Frezeler / S System Modular End Mills (Screw Type Tools)

90°	AEM90-RT10	Uç / Insert	Takım Kodu / Tool Code
		RT 1003.. (For SFTY)	AEM90-RT10-D16-M08-L20-Z02-H AEM90-RT10-D20-M10-L25-Z03-H AEM90-RT10-D25-M12-L30-Z04-H AEM90-RT10-D32-M16-L43-Z05-H AEM90-RT10-D42-M16-L43-Z06-H



Frezeleme Takımları / Milling Tools

Yüzey Frezeler / Face Milling Tools

90°	AFM90-RT10	Uç / Insert	Takım Kodu / Tool Code
		RT 1003.. (For SFTY)	AFM90-RT10-D040-A16-Z06-H AFM90-RT10-D050-A22-Z07-H AFM90-RT10-D063-A22-Z09-H

Yüzey Frezeler / Face Milling Tools

45°	AFM45-SE13	Uç / Insert	Takım Kodu / Tool Code
		SEMT 13T3.. (For SMTM-DJT)	AFM45-SE13-D050-A22-Z04-H AFM45-SE13-D063-A22-Z05-H AFM45-SE13-D080-A27-Z06-H AFM45S-SE13-D050-A22-Z05-H AFM45S-SE13-D063-A22-Z06-H AFM45S-SE13-D080-A27-Z08-H AFM45S-SE13-D100-A32-Z10-H AFM45S-SE13-D125-B40-Z12

Yüzey Frezeler / Face Milling Tools

45°	AFM45-SA1706	Uç / Insert	Takım Kodu / Tool Code
		SAKU 1706.. (For CRTZT)	AFM45-SA1706-D080-A27-Z06-H AFM45-SA1706-D100-A32-Z07-H AFM45-SA1706-D125-B40-Z09

Yüzey Frezeler / Face Milling Tools

90°	AEM90-S0803	Uç / Insert	Takım Kodu / Tool Code
		SOMT 0803.. (For SMTM)	AEM90-S00803-D20-C16-L110-Z02-H AEM90-S00803-D25-C20-L110-Z02-H AEM90-S00803-D32-C25-L120-Z03-H

Yüzey Frezeler / Face Milling Tools

90°	AFM90-SD..	Uç / Insert	Takım Kodu / Tool Code
		SD.. 09M4.. (For KRLY)	AFM90-SD09M4-D040-A16-Z04-H AFM90-SD09M4-D050-A22-Z05-H AFM90-SD09M4-D063-A22-Z06-H
		SD.. 1305.. (For KRLY)	AFM90-SD1305-D050-A22-Z04-H AFM90-SD1305-D063-A22-Z05-H AFM90-SD1305-D080-A27-Z06-H AFM90-SD1305-D100-A32-Z07-H AFM90-SD1305-D125-B40-Z08 AFM90-SD1305-D160-C40-Z10

Yüzey Frezeler / Face Milling Tools

45°	AFM45-SE..	Uç / Insert	Takım Kodu / Tool Code
		SE.. 12T3..-R245-12T3.. (For ZCC-SNDVK)	AFM45-SE12-D050-A22-Z04-H AFM45L-SE12-D050-A22-Z04-H AFM45-SE12-D063-A22-Z05-H AFM45L-SE12-D063-A22-Z05-H AFM45-SE12-D080-A27-Z06-H AFM45L-SE12-D080-A27-Z06-H AFM45-SE12-D100-A32-Z07-H AFM45-SE12-D125-B40-Z08 AFM45-SE12-D160-C40-Z10 AFM45L-SE12-D160-C40-Z10 AFM45-SE12-D200-C60-Z12
		SE.. 14M4.. (For KRLY)	AFM45-SE14M4-D063-A22-Z04-H AFM45-SE14M4-D080-A27-Z05-H AFM45-SE14M4-D100-A32-Z05-H AFM45-SE14M4-D125-B40-Z06 AFM45-SE14M4-D160-C40-Z07

Yüzey Frezeler / Face Milling Tools

90°	AFM90S-SD1204	Uç / Insert	Takım Kodu / Tool Code
		SDMT 1204.. (For DJT)	AFM90S-SD1204-D050-A22-Z04-H AFM90S-SD1204-D063-A22-Z05-H AFM90S-SD1204-D080-A27-Z06-H AFM90S-SD1204-D100-A32-Z08-H AFM90S-SD1204-D125-B40-Z10 AFM90S-SD1204-D160-C40-Z12

Yüzey Frezeler / Face Milling Tools

90°	AFM90-SE12	Uç / Insert	Takım Kodu / Tool Code
		SEET 1203.. (For ZCC)	AFM90-SE12-D050 A22 Z04-H AFM90-SE12-D063 A22 Z05-H AFM90-SE12-D080 A27 Z07-H AFM90-SE12-D100 A32 Z09-H AFM90-SE12-D125 B40 Z11

S Sistem Yüzey Parmak Frezeler / S System End Mills

90°	AEM90-SE09	Uç / Insert	Takım Kodu / Tool Code
		SEET 09T3.. (For ZCC)	AEM90-SE09-D25-C25-L120-Z03-H AEM90-SE09-D25-C25-L150-Z02 AEM90-SE09-D32-C32-L120-Z04-H AEM90-SE09-D32-C32-L150-Z03

Yüzey Frezeler / Face Milling Tools

45°	AFM45C-SN1206	Uç / Insert	Takım Kodu / Tool Code
		SN.. 1206.. (For KRLY-PLBT-BHLR)	AFM45C-SN1206-D050-A22-Z04-H AFM45C-SN1206-D050-A22-Z05-H AFM45CL-SN1206-D050-A22-Z05-H AFM45C-SN1206-D063-A22-Z06-H AFM45C-SN1206-D063-A22-Z07-H AFM45CL-SN1206-D063-A22-Z07-H AFM45C-SN1206-D080-A27-Z07-H AFM45C-SN1206-D080-A27-Z08-H AFM45CL-SN1206-D080-A27-Z08-H AFM45C-SN1206-D100-A32-Z08-H AFM45C-SN1206-D100-A32-Z10-H AFM45CL-SN1206-D100-A32-Z10-H AFM45C-SN1206-D125-B40-Z11 AFM45CL-SN1206-D125-B40-Z11 AFM45C-SN1206-D160-C40-Z12 AFM45C-SN1206-D200-C60-Z14 AFM45CL-SN1206-D200-C60-Z14

Yüzey Frezeler / Face Milling Tools

90°	AFM90-SE09	Uç / Insert	Takım Kodu / Tool Code
		SEET 09T3.. (For ZCC)	AFM90-SE09-D040-A16-Z04-H AFM90-SE09-D050-A22-Z05-H AFM90-SE09-D063-A22-Z06-H

Frezeleme Takımları / Milling Tools

Yüzey Frezeler / Face Milling Tools

45°	AFM45C-SN..	Uç / Insert	Takım Kodu / Tool Code
		SN.. 12... (For WLTR-LMN-ACHTK)	AFM45C-SN12..-D050-A22-Z04-H AFM45C-SN12..-D050-A22-Z05-H AFM45C-SN12..-D063-A22-Z06-H AFM45C-SN12..-D063-A22-Z07-H AFM45CL-SN12..-D063-A22-Z07-H AFM45C-SN12..-D080-A27-Z07-H AFM45C-SN12..-D080-A27-Z08-H AFM45CL-SN12..-D080-A27-Z08-H AFM45C-SN12..-D100-A32-Z08-H AFM45C-SN12..-D100-A32-Z10-H AFM45CL-SN12..-D100-A32-Z10-H AFM45C-SN12..-D125-B40-Z11 AFM45CL-SN12..-D125-B40-Z11 AFM45C-SN12..-D160-C40-Z12 AFM45C-SN12..-D200-C60-Z14 AFM45CL-SN12..-D200-C60-Z14

Yüzey Frezeler / Face Milling Tools

88°	AFM88C-SN12Z	Uç / Insert	Takım Kodu / Tool Code
		SNEG 1205.. (For ZCC)	AFM88C-SN12Z-D063-A22-Z06-H AFM88C-SN12Z-D080-A27-Z07-H

Yüzey Frezeler / Face Milling Tools

90°	AFM90-SP1004	Uç / Insert	Takım Kodu / Tool Code
		SPMT 1004.. XPMT 1004.. QPMR 1004.. QPMT 1004.. (For ISCR)	AFM90-SP1004-D040-A16-Z04-H AFM90-SP1004-D050-A22-Z06-H

Yüzey Frezeler / Face Milling Tools

88°	AFM88-SN1305	Uç / Insert	Takım Kodu / Tool Code
		SNMU 1305.. (For KYCR)	AFM88-SN1305-D050-A22-Z04 AFM88-SN1305-D050-A22-Z05 AFM88-SN1305-D063-A22-Z05 AFM88-SN1305-D063-A22-Z07 AFM88-SN1305-D080-A27-Z06 AFM88-SN1305-D080-A27-Z09 AFM88-SN1305-D100-A32-Z07 AFM88-SN1305-D100-A32-Z11 AFM88-SN1305-D125-B40-Z13

S Sistem Yüzey Parmak Frezeler / S System End Mills

90°	AEM90-SPGT	Uç / Insert	Takım Kodu / Tool Code
		SPGT 0602.. (For ZCC) SPGT 07T3.. (For ZCC) SPGT 0904.. (For ZCC)	AEM90-SPGT0602-D16-W16-L150-Z02 AEM90-SPGT07T3-D20-W20-L150-Z03 AEM90-SPGT07T3-D25-W25-L150-Z03 AEM90-SPGT0904-D30-W32-L150-Z03

Yüzey Frezeler / Face Milling Tools

88°	AFM88-SN1306	Uç / Insert	Takım Kodu / Tool Code
		SNGX 1306.. (For TGTC)	AFM88-SN1306-D050-A22-Z05-H AFM88-SN1306-D063-A22-Z06-H AFM88-SN1306-D080-A27-Z07-H

Yüzey Frezeler / Face Milling Tools

75°	AFM75C-SP12	Uç / Insert	Takım Kodu / Tool Code
		SPKN 1203.. (For ISO)	AFM75C-SP12-D050-A22-Z04 AFM75C-SP12-D063-A22-Z05 AFM75C-SP12-D080-A27-Z06 AFM75C-SP12-D100-A32-Z07 AFM75C-SP12-D125-B40-Z08 AFM75C-SP12-D160-C40-Z09 AFM75C-SP12-D200-C60-Z12

Yüzey Frezeler / Face Milling Tools

88°	AFM88C-SN1206	Uç / Insert	Takım Kodu / Tool Code
		SN.. 1206.. (For ISO) SN.. 12.. (For ISO)	AFM88C-SN1206-D063-A22-Z06-H AFM88C-SN1206-D080-A27-Z07-H AFM88C-SN1206-D100-A32-Z09-H AFM88C-SN12..-D063-A22-Z06-H AFM88C-SN12..-D080-A27-Z07-H AFM88C-SN12..-D100-A32-Z09-H

S Sistem Yüzey Parmak Frezeler / S System End Mills

90°	AEM90-TNG10	Uç / Insert	Takım Kodu / Tool Code
		TNGX 1004.. (For PRMT)	AEM90-TNG10-D20-C20-L125-Z02-H AEM90-TNG10-D20-C20-L125-Z03-H AEM90-TNG10-D20-C20-L150-Z03-H AEM90-TNG10-D25-C25-L150-Z03-H AEM90-TNG10-D25-C25-L150-Z04-H AEM90-TNG10-D25-C25-L170-Z04-H AEM90-TNG10-D32-C32-L170-Z04-H AEM90-TNG10-D32-C32-L170-Z05-H

Yüzey Frezeler / Face Milling Tools

45°	AFM45C-SN12Z	Uç / Insert	Takım Kodu / Tool Code
		SNEG 1205.. (For ZCC)	AFM45C-SN12Z-D050-A22-Z05-H AFM45C-SN12Z-D063-A22-Z06-H AFM45C-SN12Z-D080-A27-Z07-H AFM45C-SN12Z-D100-A32-Z09-H AFM45C-SN12Z-D125-B40-Z11 AFM45C-SN12Z-D160-C40-Z12 AFM45C-SN12Z-D200-C60-Z14

Yüzey Frezeler / Face Milling Tools

90°	AFM90-TN2207	Uç / Insert	Takım Kodu / Tool Code
		TN.X 2207.. (For TGTC)	AFM90-TN2207-D063-A22-Z04-H AFM90-TN2207-D080-A27-Z05-H AFM90-TN2207-D100-B32-Z06 AFM90-TN2207-D125-B40-Z08



Frezeleme Takımları / Milling Tools

Yüze Frezeler / Face Milling Tools

90°	AFM90C-TP..	Uç / Insert	Takım Kodu / Tool Code
		TP. 1603 (For ISO)	AFM90C-TP16-D050-A22-Z04 AFM90C-TP16-D063-A22-Z06 AFM90C-TP16-D080-A27-Z07 AFM90C-TP16-D100-A32-Z08 AFM90C-TP16-D125-B40-Z08
		TP. 2204 (For ISO)	AFM90C-TP22-D063-A22-Z05 AFM90C-TP22-D080-A27-Z06 AFM90C-TP22-D100-A32-Z07 AFM90C-TP22-D125-B40-Z08 AFM90C-TP22-D160-C40-Z09 AFM90C-TP22-D200-C60-Z12 AFM90C-TP22-D250-C60-Z15 AFM90C-TP22-D315-D60-Z18

Yüze Frezeler / Face Milling Tools

90°	AFM90-WN..	Uç / Insert	Takım Kodu / Tool Code
		WNHU 0604.. (For ZCC)	AFM90-WN0604Z-D040-A16-Z04-H AFM90-WN0604Z-D050-A22-Z05-H AFM90-WN0604Z-D063-A22-Z06-H AFM90-WN0604Z-D080-A27-Z07-H AFM90-WN0604Z-D100-A32-Z09-H
		WNHU 0806.. (For ZCC)	AFM90-WN0806Z-D050-A22-Z04-H AFM90-WN0806Z-D063-A22-Z05-H AFM90-WN0806Z-D080-A27-Z06-H AFM90-WN0806Z-D100-A32-Z08-H AFM90-WN0806Z-D125-B40-Z10 AFM90-WN0806Z-D160-C40-Z12

Yüze Frezeler / Face Milling Tools

90°	AFM90-TP2205	Uç / Insert	Takım Kodu / Tool Code
		TPKT 2205.. (For TGTC)	AFM90-TP2205-D063-A22-Z04 AFM90-TP2205-D080-A27-Z06 AFM90-TP2205-D100-A32-Z07 AFM90-TP2205-D125-B40-Z08 AFM90-TP2205-D160-C40-Z09 AFM90-TP2205-D200-C60-Z12

S Sistem Yüze Parmak Frezeler / S System End Mills

90°	AEM90-XC13	Uç / Insert	Takım Kodu / Tool Code
		XCKX 13T3.. (For SC)	AEM90-XC13-D20-W20-L150-Z02 AEM90-XC13-D25-W25-L150-Z03 AEM90-XC13-D32-W32-L150-Z04

Yüze Frezeler / Face Milling Tools

90°	AFM90-WN0806	Uç / Insert	Takım Kodu / Tool Code
		WNMX 080608 (For KYCR-JD)	AFM90-WN0806-D050-A16-Z04-H AFM90-WN0806-D063-A22-Z05-H AFM90-WN0806-D080-A27-Z07-H

S Sistem Modüler Parmak Frezeler / S System Modular End Mills (Screw Type Tools)

95°	AEM95-XD..	Uç / Insert	Takım Kodu / Tool Code
		XDHW 0206.. (For DJT)	AEM95-XD0206-D16-M08-L23-Z02-H AEM95-XD0206-D16-M08-L23-Z02-H-F AEM95-XD0206-D20-M10-L30-Z03-H AEM95-XD0206-D20-M10-L30-Z03-H-F AEM95-XD0206-D25-M12-L35-Z03-H AEM95-XD0206-D25-M12-L35-Z03-H-F AEM95C-XD0310-D35-M16-L43-Z03-H
		XDHW 0310.. (For DJT)	AEM95C-XD0310-D35-M16-L43-Z03-H-F AEM95C-XD0310-D42-M16-L43-Z04-H AEM95C-XD0310-D42-M16-L43-Z04-H-F

S Sistem Modüler Parmak Frezeler / S System Modular End Mills (Screw Type Tools)

90°	AEM90-WN0604Z	Uç / Insert	Takım Kodu / Tool Code
		WNHU 0604.. (For ZCC)	AEM90-WN0604Z-D25-M12-L35-Z02-H AEM90-WN0604Z-D32-M16-L43-Z03-H AEM90-WN0604Z-D40-M16-L43-Z04-H

Yüze Frezeler / Face Milling Tools

42°	AFM42C-XD0806	Uç / Insert	Takım Kodu / Tool Code
		XDMW 0806.. (For DJT)	AFM42C-XD0806-D063-A27-Z04-H AFM42C-XD0806-D080-A27-Z05-H AFM42C-XD0806-D100-A32-Z06-H AFM42C-XD0806-D125-B40-Z07 AFM42C-XD0806-D160-C40-Z08 AFM42C-XD0806-D200-C60-Z09

S Sistem Yüze Parmak Frezeler / S System End Mills

90°	AEM90-WN0604Z	Uç / Insert	Takım Kodu / Tool Code
		WNHU 0604.. (For ZCC)	AEM90-WN0604Z-D25-W25-L150-Z02-H AEM90-WN0604Z-D32-W32-L150-Z03-H AEM90-WN0604Z-D40-W32-L150-Z04-H

Yüze Frezeler / Face Milling Tools

90°	AFM90-XN0806	Uç / Insert	Takım Kodu / Tool Code
		XNEX 0806.. (For SC)	AFM90-XN0806-D050-A22-Z04-H AFM90-XN0806-D063-A22-Z05-H AFM90-XN0806-D080-A27-Z07-H AFM90-XN0806-D100-A32-Z08-H

S Sistem Yüze Parmak Frezeler / S System End Mills

90°	AEM90-XD11T3	Uç / Insert	Takım Kodu / Tool Code
		XD.T 11T3.. (For CRTZT)	AEM90-XD11T3-D16-W16-L150-Z02 AEM90-XD11T3-D17-C16-L150-Z02 AEM90-XD11T3-D20-W20-L150-Z03 AEM90-XD11T3-D21-C20-L080-Z03-H AEM90-XD11T3-D21-C20-L150-Z03 AEM90-XD11T3-D25-W25-L150-Z04 AEM90-XD11T3-D32-W32-L150-Z04 AEM90-XD11T3-D33-C20-L080-Z04-H

Yüze Frezeler / Face Milling Tools

45°	AFM45-XN0906	Uç / Insert	Takım Kodu / Tool Code
		XNNU 0906.. (For TGTC)	AFM45-XN0906-D063-A22-Z06-H AFM45-XN0906-D080-A27-Z06-H AFM45-XN0906-D100-A32-Z07-H AFM45-XN0906-D125-B40-Z08

Frezeleme Takımları / Milling Tools

Yüze Frezeler / Face Milling Tools

45°	AFM45C-XN0806	Uç / Insert	Takım Kodu / Tool Code
		XNMU 0806.. (For DJT)	AFM45C-XN0806-D063-A22-Z05 AFM45C-XN0806-D080-A27-Z06 AFM45C-XN0806-D100-A32-Z08 AFM45C-XN0806-D125-B40-Z08 AFM45C-XN0806-D160-C40-Z10 AFM45C-XN0806-D200-C60-Z12

S Sistem Yüze Parmak Frezeler / S System End Mills

90°	AEM90-ZP13T3	Uç / Insert	Takım Kodu / Tool Code
		ZPMT 13T3.. (For DJT)	AEM90-ZP13T3-D26-C25-L200-Z02 AEM90-ZP13T3-D26-C25-L200-Z03 AEM90-ZP13T3-D26-C25-L250-Z02 AEM90-ZP13T3-D33-C32-L200-Z03 AEM90-ZP13T3-D33-C32-L250-Z03

S Sistem Yüze Parmak Frezeler / S System End Mills

90°	AEM90-XO..	Uç / Insert	Takım Kodu / Tool Code
		XO.. 0602.. (For SC)	AEM90-XO06-D10-C12-L120-Z02 AEM90-XO06-D12-C12-L120-Z02
		XO.. 0903.. (For SC)	AEM90-XO09-D16-W16-L150-Z02 AEM90-XO09-D20-W20-L150-Z03
		XO.. 1204.. (For SC)	AEM90-XO12-D20-W20-L150-Z02 AEM90-XO12-D20-C20-L200-Z02
			AEM90-XO12-D22-W20-L150-Z02 AEM90-XO12-D25-W25-L150-Z03 AEM90-XO12-D25-C25-L200-Z03 AEM90-XO12-D32-C25-L150-Z04 AEM90-XO12-D32-W32-L150-Z04 AEM90-XO12-D32-C32-L250-Z04

S Sistem Yüze ve Kopya Parmak Frezeler / S System Face and Copy End Mills

-°	AEMR-QP..	Uç / Insert	Takım Kodu / Tool Code
		QP.. 10T3.. (For SMTM)	AEMR-QP10T3-D20-C20-L150-Z01-H AEMR-QP10T3-D25-C25-L120-Z02-H AEMR-QP10T3-D25-C25-L150-Z02-H AEMR-QP10T3-D25-C25-L170-Z02 AEMR-QP10T3-D32-C32-L150-Z03-H AEMR-QP10T3-D32-C32-L170-Z03
		QP.. 1204.. (For SMTM)	AEMR-QP1204-D25-C25-L150-Z02-H

Yüze Frezeler / Face Milling Tools

75°	AFM75-X012	Uç / Insert	Takım Kodu / Tool Code
		XO.. 1204.. (For SC)	AFM75-X012-D050-A22-Z04-H AFM75-X012-D063-A22-Z05-H AFM75-X012-D080-A27-Z06-H

S Sistem Modüler Parmak Frezeler / S System Modular End Mills (Screw Type Tools)

-°	AEMR-QP10T3	Uç / Insert	Takım Kodu / Tool Code
		QP.. 10T3.. (For SMTM)	AEMR-QP10T3-D25-M12-L35-Z02-H AEMR-QP10T3-D32-M16-L43-Z03-H

Yüze Frezeler / Face Milling Tools

90°	AFM90-X012	Uç / Insert	Takım Kodu / Tool Code
		XO.. 1204.. (For SC)	AFM90-X012-D040-A16-Z05-H AFM90-X012-D050-A22-Z07-H AFM90-X012-D063-A22-Z08-H AFM90-X012-D080-A27-Z10-H AFM90-X012-D100-A32-Z12-H

Yüze ve Kopya Frezeler / Face and Copy Milling Tools

-°	AFMR-QP..	Uç / Insert	Takım Kodu / Tool Code
		QP.. 10T3.. (For SMTM)	AFMR-QP10T3-D040-A16-Z04-H AFMR-QP10T3-D050-A22-Z05-H AFMR-QP10T3-D063-A22-Z06-H
		QP.. 1204.. (For SMTM)	AFMR-QP1204-D050-A22-Z04-H AFMR-QP1204-D063-A22-Z05-H

S Sistem Yüze Parmak Frezeler / S System End Mills

90°	AEM90-ZC1003	Uç / Insert	Takım Kodu / Tool Code
		ZCMT 100308R (For DJT)	AEM90-ZC1003-D16-C14-L150-Z02 AEM90-ZC1003-D16-C14-L200-Z02 AEM90-ZC1003-D16-C15-L150-Z02 AEM90-ZC1003-D16-C16-L150-Z02 AEM90-ZC1003-D17-C16-L150-Z02 AEM90-ZC1003-D17-C16-L200-Z02 AEM90-ZC1003-D20-C18-L150-Z03 AEM90-ZC1003-D20-C18-L200-Z02 AEM90-ZC1003-D20-C20-L150-Z03 AEM90-ZC1003-D20-C18-L200-Z03 AEM90-ZC1003-D21-C20-L150-Z02 AEM90-ZC1003-D21-C20-L150-Z03 AEM90-ZC1003-D21-C20-L200-Z03 AEM90-ZC1003-D25-C20-L150-Z03 AEM90-ZC1003-D25-C20-L200-Z03 AEM90-ZC1003-D25-C25-L150-Z03 AEM90-ZC1003-D26-C25-L170-Z03 AEM90-ZC1003-D26-C25-L200-Z03 AEM90-ZC1003-D32-C25-L180-Z04 AEM90-ZC1003-D32-C32-L200-Z04

S Sistem Modüler Parmak Frezeler / S System Modular End Mills (Screw Type Tools)

-°	AEMR-RC10T3	Uç / Insert	Takım Kodu / Tool Code
		RC.. 10T3.. (For ZCC)	AEMR-RC10T3-D25-M12-L35-Z03-H AEMR-RC10T3-D32-M16-L43-Z04-H AEMR-RC10T3-D40-M16-L43-Z05-H

Yüze ve Kopya Frezeler / Face and Copy Milling Tools

-°	AFMR-RC10T3	Uç / Insert	Takım Kodu / Tool Code
		RC.. 10T3.. (For ZCC)	AFMR-RC10T3-D040-A16-Z04-H AFMR-RC10T3-D050-A22-Z05-H AFMR-RC10T3-D063-A22-Z06-H



Yüzey ve Kopya Frezeler / Face and Copy Milling Tools

-°	AFMR-RC1204	Uç / Insert	Takım Kodu / Tool Code
		RC. 1204.. (For SNDVK)	AFMR-RC1204-D040-A16-Z04-H AFMR-RC1204-D050-A22-Z05-H AFMR-RC1204-D052-A22-Z05-H AFMR-RC1204-D063-A22-Z06-H AFMR-RC1204-D063-A27-Z06-H AFMR-RC1204-D080-A27-Z07-H

S Sistem Modüler Parmak Frezeler / S System Modular End Mills (Screw Type Tools)

-°	AEMR-RD..	Uç / Insert	Takım Kodu / Tool Code
		RD.. 07T1	AEMR-RD07T1-D12-M07-L23-Z02-H AEMR-RD0702-D15-M08-L23-Z02-H AEMR-RD0702-D16-M08-L23-Z02-H AEMR-RD0702-D20-M10-L30-Z04-H AEMR-RD0702-D25-M12-L35-Z05-H AEMR-RD0702-D30-M16-L42-Z05-H AEMR-RD0702-D32-M16-L43-Z05-H AEMR-RD0702-D35-M16-L42-Z06-H AEMR-RD0702-D42-M16-L43-Z05-H AEMR-RD0702-D42-M16-L43-Z07-H
		RD.. 08T2 (For ISO)	AEMR-RD08T2-D16-M08-L23-Z02-H AEMR-RD08T2-D16-M10-L23-Z02-H AEMR-RD08T2-D20-M10-L30-Z03-H AEMR-RD08T2-D25-M12-L35-Z04-H
		RD.. 0803 (For ISO)	AEMR-RD0803-D16-M08-L23-Z02-H AEMR-RD0803-D20-M10-L30-Z03-H AEMR-RD0803-D25-M12-L35-Z04-H
		RD.. 1003 (For ISO)	AEMR-RD1003-D20-M10-L30-Z02-H AEMR-RD1003-D25-M12-L35-Z02-H AEMR-RD1003-D25-M12-L35-Z03-H AEMR-RD1003-D30-M16-L43-Z04-H AEMR-RD1003-D32-M16-L43-Z04-H AEMR-RD1003-D35-M16-L43-Z04-H AEMR-RD1003-D40-M16-L43-Z05-H AEMR-RD1003-D42-M16-L43-Z05-H
		RD.. 12T3 (For ISO)	AEMR-RD12T3-D24-M12-L35-Z02-H AEMR-RD12T3-D25-M12-L35-Z02-H AEMR-RD12T3-D32-M16-L43-Z03-H AEMR-RD12T3-D35-M16-L43-Z03-H AEMR-RD12T3-D35-M16-L43-Z04-H AEMR-RD12T3-D40-M16-L43-Z04-H AEMR-RD12T3-D42-M16-L43-Z05-H
		RD.. 1204 (For ISO)	AEMR-RD1204-D32-M16-L43-Z03-H AEMR-RD1204-D42-M16-L43-Z04-H
		RD.. 1604 (For ISO)	AEMR-RD1604-D32-M16-L43-Z02-H AEMR-RD1604-D40-M16-L43-Z02-H AEMR-RD1604-D42-M16-L43-Z03-H

S Sistem Yüzey ve Kopya Parmak Frezeler / S System Face and Copy End Mills



-°	AEMRC-RD..	Uç / Insert	Takım Kodu / Tool Code
		RD.. 0501.. (For ISO)	AEMRC-RD0501-D08-W10-L100-Z01-H AEMRC-RD0501-D10-W12-L100-Z02-H AEMRC-RD0501-D12-W12-L120-Z02-H
		RD.. 08T2.. (For ISO)	AEMRC-RD08T2-D16-W16-L150-Z02 AEMRC-RD08T2-D20-W20-L150-Z02
		RD.. 0803.. (For ISO)	AEMRC-RD0803-D16-W16-L150-Z02 AEMRC-RD0803-D16-C20-L200-Z02 AEMRC-RD0803-D20-W20-L150-Z03
		RD.. 1003.. (For ISO)	AEMRC-RD1003-D20-W20-L150-Z02 AEMRC-RD1003-D20-C20-L160-Z02 AEMRC-RD1003-D20-C20-L250-Z02 AEMRC-RD1003-D21-C20-L160-Z02 AEMRC-RD1003-D25-W25-L150-Z02 AEMRC-RD1003-D25-C25-L160-Z02 AEMRC-RD1003-D25-W25-L200-Z02 AEMRC-RD1003-D25-C25-L200-Z02 AEMRC-RD1003-D25-C25-L250-Z02 AEMRC-RD1003-D26-C25-L160-Z02 AEMRC-RD1003-D32-W32-L150-Z03 AEMRC-RD1003-D32-C32-L250-Z02 AEMRC-RD1003-D33-C32-L160-Z03 AEMRC-RD1003-D40-W32-L150-Z04 AEMRC-RD1003-D40-C32-L250-Z02
		RD.. 10T3.. (For ISO)	AEMRC-RD10T3-D20-W20-L150-Z02 AEMRC-RD10T3-D25-W25-L150-Z02 AEMRC-RD10T3-D32-W32-L150-Z03
		RD.. 12T3.. (For ISO)	AEMRC-RD12T3-D25-W25-L150-Z02 AEMRC-RD12T3-D25-W25-L200-Z02 AEMRC-RD12T3-D25-C25-L250-Z02 AEMRC-RD12T3-D25-C25-L300-Z02 AEMRC-RD12T3-D32-W32-L150-Z03 AEMRC-RD12T3-D32-C32-L250-Z02 AEMRC-RD12T3-D40-W32-L150-Z04 AEMRC-RD12T3-D40-C32-L250-Z02
		RD.. 1204.. (For ISO)	AEMRC-RD1204-D32-C32-L160-Z03 AEMRC-RD1204-D32-W32-L160-Z03 AEMRC-RD1204-D33-C32-L160-Z03
		RD.. 1604.. (For ISO)	AEMRC-RD1604-D40-W32-L150-Z02

Yüzey ve Kopya Frezeler / Face and Copy Milling Tools



-°	AFMRC-RD..	Uç / Insert	Takım Kodu / Tool Code
		RD..0702.. (For ISO)	AFMRC-RD0702-D050-A22-Z06-H
		RD..0803.. (For ISO)	AFMRC-RD0803-D050-A22-Z05-H
		RD..1003.. (For ISO)	AFMRC-RD1003-D040-A16-Z04-H AFMRC-RD1003-D050-A22-Z05-H AFMRC-RD1003-D063-A22-Z06-H AFMRC-RD1003-D080-A27-Z07-H AFMRC-RD1003-D100-A32-Z08-H
		RD..10T3.. (For ISO)	AFMRC-RD10T3-D050-A22-Z05-H AFMRC-RD10T3-D063-A22-Z06-H
		RD..12T3.. (For ISO)	AFMRC-RD12T3-D040-A16-Z04-H AFMRC-RD12T3-D050-A22-Z05-H AFMRC-RD12T3-D052-A22-Z05-H AFMRC-RD12T3-D063-A22-Z06-H AFMRC-RD12T3-D080-A27-Z07-H AFMRC-RD12T3-D100-A32-Z08-H AFMRC-RD12T3-D125-B40-Z09
		RD..1204.. (For ISO)	AFMRC-RD1204-D040-A16-Z04-H AFMRC-RD1204-D050-A22-Z05-H AFMRC-RD1204-D052-A22-Z05-H AFMRC-RD1204-D063-A22-Z06-H AFMRC-RD1204-D080-A27-Z07-H AFMRC-RD1204-D100-A32-Z07-H AFMRC-RD1204-D100-A32-Z08-H
		RD..1604.. (For ISO)	AFMRC-RD1604-D050-A22-Z04-H AFMRC-RD1604-D052-A22-Z04-H AFMRC-RD1604-D063-A22-Z05-H AFMRC-RD1604-D066-A22-Z05-H AFMRC-RD1604-D066-A27-Z05-H AFMRC-RD1604-D080-A27-Z05-H AFMRC-RD1604-D080-A27-Z06-H AFMRC-RD1604-D100-A32-Z07-H AFMRC-RD1604-D125-B40-Z07

Frezeleme Takımları / Milling Tools

S Sistem Modüler Parmak Frezeler / S System Modular End Mills (Screw Type Tools)

°	AEMR-RP..	Uç / Insert	Takım Kodu / Tool Code
		RPMT 08T2.. (For MTSBSH)	AEMR-RP08T2M-D20-M10-L30-Z02-H
		RPMT 10T3.. (For MTSBSH)	AEMR-RP10T3M-D25-M12-L35-Z02-H
		RPMT 1204.. (For MTSBSH)	AEMR-RP10T3M-D32-M16-L43-Z03-H
		RPMT 1204.. (For MTSBSH)	AEMR-RP1204M-D32-M16-L43-Z03-H
		RPMT 1204.. (For MTSBSH)	AEMR-RP1204M-D40-M16-L43-Z04-H

S Sistem Yüze ve Kopya Parmak Frezeler / S System Face and Copy End Mills

°	AEMR-RP..	Uç / Insert	Takım Kodu / Tool Code
		RPMT 08T2.. (For MTSBSH)	AEMR-RP08T2M-D20-W20-L150-Z02-H
		RPMT 10T3..	AEMR-RP08T2M-D25-W25-L200-Z03-H
		RPMT 1204..	AEMR-RP10T3M-D25-W25-L200-Z02-H
		RPMT 1204.. (For MTSBSH)	AEMR-RP1204M-D32-W32-L150-Z03-H
		RPMT 1204.. (For MTSBSH)	AEMR-RP1204M-D32-W32-L200-Z03-H

Yüze ve Kopya Frezeler / Face and Copy Milling Tools

°	AFMR-RP1204M	Uç / Insert	Takım Kodu / Tool Code
		RPMT 1204.. (For MTSBSH)	AFMR-RP1204M-D050-A22-Z04-H
			AFMR-RP1204M-D052-A22-Z05-H
			AFMR-RP1204M-D063-A22-Z05-H
			AFMR-RP1204M-D080-A27-Z06-H

S Sistem Yüze ve Kopya Parmak Frezeler / S System Face and Copy End Mills

°	AEMR-RP10T3	Uç / Insert	Takım Kodu / Tool Code
		RPNX 10T3.. (For CRTZT)	AEMR-RP10T3-D25-W25-L150-Z02
			AEMR-RP10T3-D32-W32-L150-Z03



S Sistem Modüler Parmak Frezeler / S System Modular End Mills (Screw Type Tools)

°	AEMR-RP10T3	Uç / Insert	Takım Kodu / Tool Code
		RPNX 10T3.. (For CRTZT)	AEMR-RP10T3-D25-M12-L35-Z02-H
			AEMR-RP10T3-D32-M16-L43-Z03-H

Yüze ve Kopya Frezeler / Face and Copy Milling Tools

°	AFMR-RP..	Uç / Insert	Takım Kodu / Tool Code
		RPNX 10T3.. (For CRTZT)	AFMR-RP10T3-D063-A22-Z06-H
			AFMR-RP10T3-D080-A27-Z07-H
		RPNX 1204.. (For CRTZT)	AFMR-RP1204-D040-A16-Z04-H
			AFMR-RP1204-D080-A27-Z07-H

S Sistem Modüler Parmak Frezeler / S System Modular End Mills (Screw Type Tools)

°	AEMR-RY..	Uç / Insert	Takım Kodu / Tool Code
		RYMX 1004.. (For TGTC)	AEMR-RY10-D32-M16-L43-Z04-H
			AEMR-RY10-D40-M16-L43-Z05-H
		RYMX 1205.. (For TGTC)	AEMR-RY12-D32-M16-L43-Z03-H
			AEMR-RY12-D40-M16-L43-Z03-H



Yüze ve Kopya Frezeler / Face and Copy Milling Tools

°	AEMR-RY..	Uç / Insert	Takım Kodu / Tool Code
		RYMX 0803..	AEMR-RY08-D16-W16-L150-Z02
			AEMR-RY10-D20-W20-L150-Z02
	RYMX 1004.. (For TGTC)		AEMR-RY10-D20-C20-L200-Z02
			AEMR-RY10-D21-W20-L200-Z02-H
			AEMR-RY10-D25-W25-L150-Z02
			AEMR-RY10-D25-W25-L150-Z03
			AEMR-RY10-D26-W25-L200-Z02-H
			AEMR-RY10-D32-W32-L160-Z04-H
	RYMX 1205..	AEMR-RY12-D32-C25-L160-Z03	

Yüze ve Kopya Frezeler / Face and Copy Milling Tools

°	AFMR-RY..	Uç / Insert	Takım Kodu / Tool Code
	RYMX 1004.. (For TGTC)		AFMR-RY10-D040-A16-Z04-H
			AFMR-RY10-D040-A16-Z05-H
	RYMX 1205.. (For TGTC)		AFMR-RY10-D050-A22-Z05-H
			AFMR-RY10-D063-A22-Z06-H
			AFMR-RY12-D040-A16-Z04-H
			AFMR-RY12-D050-A22-Z05-H
			AFMR-RY12-D052-A22-Z05-H
			AFMR-RY12-D063-A22-Z06-H
			AFMR-RY12-D080-A27-Z06-H
			AFMR-RY12-D100-A32-Z07-H

Küre Uçlu Parmak Frezeler / Profile Milling Tools

°	APMR-BNM..	Uç / Insert	Takım Kodu / Tool Code
		BNM-120-S	APMR-BNM12-D12-C12-L130
		BNM-160-S (For DJT)	APMR-BNM16-D16-C16-L175

Küre Uçlu Parmak Frezeler / Profile Milling Tools

°	APMR-P32..	Uç / Insert	Takım Kodu / Tool Code
		P3208 - (For WLTR)	APMR-P3208-D08-C10-L110
		P3210 - (For WLTR)	APMR-P3210-D10-C10-L130
			APMR-P3210-D10-C12-L130
		P3212 - (For WLTR)	APMR-P3212-D12-C12-L130
		P3216 - (For WLTR)	APMR-P3216-D16-C16-L175
		P3220 - (For WLTR)	APMR-P3220-D20-C20-L200
		P3225 - (For WLTR)	APMR-P3225-D25-C25-L200
		P3232 - (For WLTR)	APMR-P3232-D32-C32-L200

Küre Uçlu Modüler Parmak Frezeler / Ball Nose Modular End Mills (Screw Type Tools)

°	APMR-PR..	Uç / Insert	Takım Kodu / Tool Code
		P3216 - (For WLTR)	APMR-P3216-D16-M08-L25
		P3220 - (For WLTR)	APMR-P3220-D20-M10-L30
		P3225 - (For WLTR)	APMR-P3225-D25-M12-L35
		P3232 - (For WLTR)	APMR-P3232-D32-M16-L43

Küre Uçlu Parmak Frezeler / Profile Milling Tools

°	APMR-RO..	Uç / Insert	Takım Kodu / Tool Code
		ROHX 1203 (For ZCC)	APMR-RO12-D12-C12-L120
			APMR-RO12-D12-C16-L160
		ROHX 1604 (For ZCC)	APMR-RO16-D16-C16-L160
			APMR-RO16-D16-C16-L200
			APMR-RO16-D16-C20-L200
		ROHX 2005 (For ZCC)	APMR-RO20-D20-C20-L160
	APMR-RO20-D20-C20-L200		
		APMR-RO20-D20-C25-L220	



Frezeleme Takımları / Milling Tools

38/39

Küre Uçlu Modüler Parmak Frezeler / Ball Nose Modular End Mills (Screw Type Tools)

-°	APMR-SWB..	Uç / Insert	Takım Kodu / Tool Code
		SWB225HM-HS - (For DJT)	APMR-SWB225-D25-M12-L35
		SWB230HM-HS - (For DJT)	APMR-SWB230-D30-M16-L43
		SWB232HM-HS - (For DJT)	APMR-SWB232-D32-M16-L43

Hızlı İlerlemeli Frezeler / High Feed Milling Tools

-°	AHFM-BL0904	Uç / Insert	Takım Kodu / Tool Code
		BLMP 0904.. (For TGTC)	AHFM-BL0904-D040-A16-Z05-H AHFM-BL0904-D050-A22-Z06-H AHFM-BL0904-D063-A22-Z05-H AHFM-BL0904-D063-A22-Z07-H

Küre Uçlu Parmak Frezeler / Profile Milling Tools

-°	APMR-XP..	Uç / Insert	Takım Kodu / Tool Code
		XPHT 16R0803 - (For ZCC)	APMR-XP16-D16-C16-L150
		XPHT 20R10T3 - (For ZCC)	APMR-XP20-D20-C20-L150
		XPHT 25R1204 - (For ZCC)	APMR-XP25-D25-C25-L150

Hızlı İlerlemeli Frezeler / High Feed Milling Tools

-°	AHFM-BL1205	Uç / Insert	Takım Kodu / Tool Code
		BLMP 1205.. (For TGTC)	AHFM-BL1205-D050-A22-Z03-H AHFM-BL1205-D063-A22-Z04-H AHFM-BL1205-D080-A27-Z05-H

Küre Uçlu Modüler Parmak Frezeler / Ball Nose Modular End Mills (Screw Type Tools)

-°	APMR-XP..	Uç / Insert	Takım Kodu / Tool Code
		XPHT 16R0803 - (For ZCC)	APMR-XP16-D16-M08-L25
		XPHT 20R10T3 - (For ZCC)	APMR-XP20-D20-M10-L30
		XPHT 25R1204 - (For ZCC)	APMR-XP25-D25-M12-L40

S Sistem Hızlı İlerlemeli Parmak Frezeler / S System Highfeed End Mills

-°	AHFM-BN10T3	Uç / Insert	Takım Kodu / Tool Code
	NEW	BNGX 10T3.. (For PRMT)	AHFM-BN10T3-D16-C16-L100-Z02-H
			AHFM-BN10T3-D16-C16-L150-Z02-H
			AHFM-BN10T3-D20-C20-L130-Z03-H
			AHFM-BN10T3-D20-C20-L130-Z04-H
			AHFM-BN10T3-D20-C20-L160-Z03-H
			AHFM-BN10T3-D25-C25-L140-Z04-H
			AHFM-BN10T3-D25-C25-L140-Z05-H
			AHFM-BN10T3-D25-C25-L180-Z04-H
			AHFM-BN10T3-D32-C32-L150-Z05-H
			AHFM-BN10T3-D32-C32-L150-Z06-H
			AHFM-BN10T3-D35-C32-L200-Z06-H

S Sistem Hızlı İlerlemeli Parmak Frezeler / S System Highfeed End Mills

-°	AHFM-BL0603	Uç / Insert	Takım Kodu / Tool Code
	BLMP 0603.. (For TGTC)	AHFM-BL0603-D16-C15-L150-Z02	
		AHFM-BL0603-D16-C16-L100-Z02-H	
		AHFM-BL0603-D16-C16-L150-Z02	
		AHFM-BL0603-D17-C16-L150-Z02	
		AHFM-BL0603-D17-W16-L170-Z02	
		AHFM-BL0603-D18-C16-L150-Z02	
		AHFM-BL0603-D18-W16-L150-Z02-H	
		AHFM-BL0603-D20-C20-L130-Z03	
		AHFM-BL0603-D20-C20-L160-Z03	
		AHFM-BL0603-D21-W20-L200-Z03	
		AHFM-BL0603-D21-C20-L200-Z03	
		AHFM-BL0603-D25-C25-L250-Z04	
		AHFM-BL0603-D26-W25-L200-Z04	
		AHFM-BL0603-D26-C25-L200-Z04	
		AHFM-BL0603-D32-C32-L150-Z05	
		AHFM-BL0603-D32-C32-L200-Z05	
		AHFM-BL0603-D33-C32-L200-Z05	

S Sistem Hızlı İlerlemeli Modüler Parmak Frezeler / S System Modular Highfeed End Mills (Screw Type Tools)

-°	AHFM-ED0702	Uç / Insert	Takım Kodu / Tool Code
		EDMT 0702 - JDMT 070204 (For HTCH)	AHFM-ED0702-D12-M06-L20-Z03 AHFM-ED0702-D16-M08-L25-Z04-H AHFM-ED0702-D20-M10-L30-Z05-H AHFM-ED0702-D25-M12-L30-Z06-H AHFM-ED0702-D32-M16-L30-Z08-H

S Sistem Hızlı İlerlemeli Modüler Parmak Frezeler / S System Modular Highfeed End Mills (Screw Type Tools)



-°	AHFM-BL..	Uç / Insert	Takım Kodu / Tool Code
		BLMP 0603 (For TGTC)	AHFM-BL0603-D32-M16-L40-Z05-H
		BLMP 0904 (For TGTC)	AHFM-BL0904-D32-M16-L40-Z04-H AHFM-BL0904-D42-M16-L43-Z05-H

S Sistem Hızlı İlerlemeli Modüler Parmak Frezeler / S System Modular Highfeed End Mills (Screw Type Tools)

-°	AHFM-EN1004	Uç / Insert	Takım Kodu / Tool Code
	NEW	ENMU 1004.. (For DJT)	AHFM-EN1004-D16-M08-L23-Z02-H
			AHFM-EN1004-D20-M10-L30-Z03-H
			AHFM-EN1004-D25-M12-L35-Z03-H
			AHFM-EN1004-D25-M12-L35-Z04-H
			AHFM-EN1004-D32-M16-L43-Z05-H
			AHFM-EN1004-D35-M16-L43-Z05-H
			AHFM-EN1004-D40-M16-L43-Z05-H
			AHFM-EN1004-D42-M16-L43-Z05-H

Frezeleme Takımları / Milling Tools

Hızlı İlerlemeli Frezeler / High Feed Milling Tools

°	AHFM-EN1004	Uç / Insert	Takım Kodu / Tool Code
		ENMU 1004.. (For DJT)	AHFM-EN1004-D050-A22-Z05-H AHFM-EN1004-D050-A22-Z06-H AHFM-EN1004-D052-A22-Z06-H AHFM-EN1004-D063-A22-Z06-H

S Sistem Hızlı İlerlemeli Parmak Frezeler / S System Highfeed End Mills

°	AHFM-E00602	Uç / Insert	Takım Kodu / Tool Code
		EO.. 060210 ZOMT 060210 (For DJT)	AHFM-E00602-D10-C10-L080-Z02 AHFM-E00602-D10-C09-L120-Z02 AHFM-E00602-D10-C10-L120-Z02 AHFM-E00602-D12-C12-L080-Z02 AHFM-E00602-D12-C12-L080-Z03 AHFM-E00602-D12-C11-L120-Z02 AHFM-E00602-D12-C11-L120-Z03 AHFM-E00602-D12-C12-L120-Z02 AHFM-E00602-D12-C12-L120-Z03 AHFM-E00602-D16-C16-L150-Z04



S Sistem Hızlı İlerlemeli Parmak Frezeler / S System Highfeed End Mills

°	AHFM-EN1004	Uç / Insert	Takım Kodu / Tool Code
		ENMU 1004.. (For DJT)	AHFM-EN1004-D16-C16-L150-Z02 AHFM-EN1004-D17-C16-L150-Z02-H AHFM-EN1004-D17-C16-L150-Z02 AHFM-EN1004-D17-C16-L200-Z02 AHFM-EN1004-D18-C16-L150-Z02 AHFM-EN1004-D20-C20-L150-Z03 AHFM-EN1004-D21-C20-L150-Z02 AHFM-EN1004-D21-C20-L150-Z03 AHFM-EN1004-D21-C20-L200-Z03 AHFM-EN1004-D22-C20-L150-Z03 AHFM-EN1004-D25-C25-L150-Z03 AHFM-EN1004-D25-C25-L150-Z04 AHFM-EN1004-D26-C25-L150-Z03 AHFM-EN1004-D26-C25-L150-Z04 AHFM-EN1004-D26-C25-L200-Z03 AHFM-EN1004-D26-C25-L200-Z03-H AHFM-EN1004-D26-C25-L250-Z03-H AHFM-EN1004-D28-C25-L200-Z04 AHFM-EN1004-D32-C32-L200-Z04 AHFM-EN1004-D33-C32-L200-Z04

Hızlı İlerlemeli Frezeler / High Feed Milling Tools

°	AHFMC-JD..	Uç / Insert	Takım Kodu / Tool Code
		JDMW 1204.. (For MTSBSH)	AHFMC-JD1204-D052-A22-Z03-H AHFMC-JD1204-D052-A22-Z04-H AHFMC-JD1204-D063-A22-Z05-H AHFMC-JD1204-D080-A27-Z06-H AHFMC-JD1204-D100-A32-Z07-H
		JDMW 1405.. (For MTSBSH)	AHFMC-JD1405-D052-A22-Z03-H AHFMC-JD1405-D063-A22-Z04-H



S Sistem Hızlı İlerlemeli Parmak Frezeler / S System Highfeed End Mills

°	AHFMC-JD1204	Uç / Insert	Takım Kodu / Tool Code
		JDMW 1204.. (For MTSBSH)	AHFMC-JD1204-D32-C32-L150-Z02 AHFMC-JD1204-D32-C32-L200-Z02 AHFMC-JD1204-D35-C32-L200-Z02 AHFMC-JD1204-D35-C32-L250-Z02

S Sistem Hızlı İlerlemeli Parmak Frezeler / S System Highfeed End Mills

°	AHFM-EP1003	Uç / Insert	Takım Kodu / Tool Code
		EP. 1003.. ZPMT 1003.. YPHW 1003.. (For DJT)	AHFM-EP1003-D16-C16-L150-Z02-H AHFM-EP1003-D17-C16-L150-Z02-H AHFM-EP1003-D20-C20-L150-Z04-H AHFM-EP1003-D21-C20-L150-Z04-H

S Sistem Hızlı İlerlemeli Modüler Parmak Frezeler / S System Modular Highfeed End Mills (Screw Type Tools)

°	AHFMC-JD1204	Uç / Insert	Takım Kodu / Tool Code
		JDMW 1204.. (For MTSBSH)	AHFMC-JD1204-D32-M16-L43-Z02-H AHFMC-JD1204-D42-M16-L43-Z03-H

S Sistem Hızlı İlerlemeli Modüler Parmak Frezeler / S System Modular Highfeed End Mills (Screw Type Tools)

°	AHFM-EP1003	Uç / Insert	Takım Kodu / Tool Code
		EP. 1003.. ZPMT 1003.. YPHW 1003.. (For DJT)	AHFM-EP1003-D16-M08-L23-Z02-H AHFM-EP1003-D20-M10-L30-Z04-H AHFM-EP1003-D25-M12-L35-Z04-H AHFM-EP1003-D32-M16-L43-Z05-H AHFM-EP1003-D35-M16-L43-Z05-H AHFM-EP1003-D42-M16-L43-Z06-H

S Sistem Hızlı İlerlemeli Parmak Frezeler / S System Highfeed End Mills

°	AHFM-LN120	Uç / Insert	Takım Kodu / Tool Code
		LNMX 1235.. (For B.OKE)	AHFM-LN120-D16-C15-L150-Z02 AHFM-LN120-D21-C20-L150-Z03 AHFM-LN120-D26-C25-L150-Z04 AHFM-LN120-D33-C32-L200-Z05

Hızlı İlerlemeli Frezeler / High Feed Milling Tools

°	AHFM-EP1003	Uç / Insert	Takım Kodu / Tool Code
		EP. 1003.. ZPMT 1003.. YPHW 1003.. (For DJT)	AHFM-EP1003-D050-A22-Z08-H AHFM-EP1003-D063-A22-Z08-H

S Sistem Hızlı İlerlemeli Modüler Parmak Frezeler / S System Modular Highfeed End Mills (Screw Type Tools) Tools

°	AHFM-LN120	Uç / Insert	Takım Kodu / Tool Code
		LNMX 1235.. (For B.OKE)	AHFM-LN120-D25-M12-L35-Z04-H AHFM-LN120-D32-M16-L43-Z05-H AHFM-LN120-D42-M16-L43-Z06-H

S Sistem Hızlı İlerlemeli Modüler Parmak Frezeler / S System Modular Highfeed End Mills (Screw Type Tools)Tools

°	AHFM-L003	Uç / Insert	Takım Kodu / Tool Code
		LOGU 0303.. (For KYCR)	AHFM-L003-D20-M10-L30-Z04-H-F AHFM-L003-D25-M12-L35-Z04-H-F AHFM-L003-D25-M12-L35-Z04-H AHFM-L003-D32-M16-L40-Z05-H-F AHFM-L003-D32-M16-L40-Z05-H AHFM-L003-D32-M16-L40-Z06-H-F AHFM-L003-D32-M16-L40-Z06-H AHFM-L003-D42-M16-L40-Z05-H AHFM-L003-D42-M16-L40-Z06-H

S Sistem Hızlı İlerlemeli Modüler Parmak Frezeler / S System Modular Highfeed End Mills (Screw Type Tools)Tools

°	AHFM-SD..	Uç / Insert	Takım Kodu / Tool Code
		SD.. 06T2.. (For ZCC)	AHFM-SD06T2-D16-M08-L23-Z02-H AHFM-SD06T2-D20-M10-L30-Z03-H AHFM-SD06T2-D25-M12-L35-Z04-H
		SD.. 09T3.. (For ZCC)	AHFMC-SD09T3-D25-M12-L30-Z02-H AHFMC-SD09T3-D32-M16-L43-Z03-H AHFMC-SD09T3-D35-M16-L43-Z03-H AHFMC-SD09T3-D40-M16-L43-Z04-H
		SD.. 1204.. (For ZCC)	AHFMC-SD1204-D32-M16-L43-Z02-H AHFMC-SD1204-D40-M16-L43-Z03-H

S Sistem Hızlı İlerlemeli Parmak Frezeler / S System Highfeed End Mills

°	AHFM-L003	Uç / Insert	Takım Kodu / Tool Code
		LOGU 0303.. (For KYCR)	AHFM-L003-D16-C15-L160-Z02 AHFM-L003-D16-C16-L100-Z02-F AHFM-L003-D16-C16-L100-Z02 AHFM-L003-D16-C16-L160-Z02 AHFM-L003-D17-C16-L180-Z02 AHFM-L003-D20-C20-L130-Z03 AHFM-L003-D20-C20-L160-Z03 AHFM-L003-D21-C20-L200-Z03 AHFM-L003-D25-C25-L140-Z04-F AHFM-L003-D25-C25-L140-Z04 AHFM-L003-D25-C25-L180-Z04 AHFM-L003-D32-C32-L200-Z05

Hızlı İlerlemeli Frezeler / High Feed Milling Tools

°	AHFMC-SD1204	Uç / Insert	Takım Kodu / Tool Code
		SD.. 1204.. (For ZCC)	AHFMC-SD1204-D050-A22-Z04-H AHFMC-SD1204-D063-A22-Z05-H AHFMC-SD1204-D080-A27-Z06-H AHFMC-SD1204-D100-A32-Z08-H

Hızlı İlerleme Frezeler / High Feed Milling Tools

°	AHFMC-SD1205	Uç / Insert	Takım Kodu / Tool Code
		SD.. 1205.. (For HTCH)	AHFMC-SD1205-D052-A22-Z04-H AHFMC-SD1205-D052-A22-Z05-H AHFMC-SD1205-D066-A22-Z05-H AHFMC-SD1205-D066-A22-Z06-H AHFMC-SD1205-D080-A27-Z06-H

Hızlı İlerlemeli Frezeler / High Feed Milling Tools

°	AHFM-L003	Uç / Insert	Takım Kodu / Tool Code
		LOGU 0303.. (For KYCR)	AHFM-L003-D040-A16-Z06-H AHFM-L003-D050-A22-Z07-H AHFM-L003-D063-A22-Z09-H

S Sistem Hızlı İlerlemeli Modüler Parmak Frezeler / S System Modular Highfeed End Mills (Screw Type Tools)Tools

°	AHFM-S00803	Uç / Insert	Takım Kodu / Tool Code
		SOMW 0803.. (For KPTK)	AHFM-S00803-D20-M10-L30-Z02-H AHFM-S00803-D25-M12-L35-Z03-H AHFM-S00803-D32-M16-L43-Z03-H AHFM-S00803-D40-M16-L43-Z04-H

S Sistem Hızlı İlerlemeli Parmak Frezeler / S System Highfeed End Mills

°	AHFM-LP0102	Uç / Insert	Takım Kodu / Tool Code
		LPGT 0102.. (For KYCR)	AHFM-LP0102-D10-C09-L120-Z02 AHFM-LP0102-D10-C10-L120-Z02 AHFM-LP0102-D12-C11-L120-Z02 AHFM-LP0102-D12-C12-L120-Z02

S Sistem Hızlı İlerlemeli Parmak Frezeler / S System Highfeed End Mills

°	AHFM-S00803	Uç / Insert	Takım Kodu / Tool Code
		SOMW 0803.. (For KPTK)	AHFM-S00803-D20-W20-L150-Z02 AHFM-S00803-D25-W25-L150-Z03 AHFM-S00803-D32-W32-L150-Z04

S Sistem Hızlı İlerlemeli Parmak Frezeler / S System Highfeed End Mills

°	AHFM-SD..	Uç / Insert	Takım Kodu / Tool Code
		SD.. 06T2.. (For ZCC)	AHFM-SD06T2-D16-C16-L150-Z02-H AHFM-SD06T2-D17-C16-L150-Z02-H AHFM-SD06T2-D20-C20-L150-Z03-H AHFM-SD06T2-D21-C20-L150-Z03-H AHFM-SD06T2-D25-C25-L150-Z04-H AHFM-SD06T2-D26-C25-L150-Z04-H
		SD.. 09T3.. (For ZCC)	AHFMC-SD09T3-D25-C25-L150-Z02 AHFMC-SD09T3-D25-W25-L150-Z02 AHFMC-SD09T3-D32-C32-L150-Z03 AHFMC-SD09T3-D32-W32-L150-Z03

Frezeleme Takımları / Milling Tools

S Sistem Hızlı İlerlemeli Parmak Frezeler / S System Highfeed End Mills

-°	AHFM-SP1004	Uç / Insert	Takım Kodu / Tool Code
		SPNW 1004.. (For DJT)	AHFM-SP1004-D25-C25-L150-Z02 AHFM-SP1004-D32-C32-L150-Z03

S Sistem Hızlı İlerlemeli Modüler Parmak Frezeler / S System Modular Highfeed End Mills (Screw Type Tools)

-°	AHFM-SO1004	Uç / Insert	Takım Kodu / Tool Code
		SOMT 1004.. (For KYCR)	AHFM-SO1004-D32-M16-L40-Z03-H AHFM-SO1004-D40-M16-L40-Z04-H AHFM-SO1004-D42-M16-L40-Z04-H

S Sistem Hızlı İlerlemeli Modüler Parmak Frezeler / S System Modular Highfeed End Mills (Screw Type Tools)

-°	AHFM-SP1004	Uç / Insert	Takım Kodu / Tool Code
		SPNW 1004.. (For DJT)	AHFM-SP1004-D32-M16-L43-Z03-H AHFM-SP1004-D35-M16-L43-Z03-H AHFM-SP1004-D42-M16-L43-Z04-H

Hızlı İlerlemeli Frezeler / High Feed Milling Tools

-°	AHFM-SO1004	Uç / Insert	Takım Kodu / Tool Code
		SOMT 1004.. (For KYCR)	AHFM-SO1004-D050-A22-Z05-H AHFM-SO1004-D063-A22-Z06-H AHFM-SO1004-D080-A27-Z07-H

Hızlı İlerlemeli Frezeler / High Feed Milling Tools

-°	AHFM-SP1004	Uç / Insert	Takım Kodu / Tool Code
		SPNW 1004.. (For DJT)	AHFM-SP1004-D050-A22-Z05-H AHFM-SP1004-D052-A22-Z05-H AHFM-SP1004-D063-A22-Z06-H

S Sistem Hızlı İlerlemeli Parmak Frezeler / S System Highfeed End Mills

-°	AHFMC-WD..	Uç / Insert	Takım Kodu / Tool Code
		WDMT 0603.. (For SMTM)	AHFM-WD0603-D16-C16-L150-Z02 AHFM-WD0603-D20-C20-L150-Z03
		WDMT 0804.. (For SMTM)	AHFMC-WD0804-D25-C25-L150-Z02 AHFMC-WD0804-D32-C32-L150-Z03
		WDMT 1205 (For SMTM)	AHFMC-WD1205-D32-C32-L150-Z02

S Sistem Hızlı İlerlemeli Parmak Frezeler / S System Highfeed End Mills

-°	AHFM-WD..	Uç / Insert	Takım Kodu / Tool Code
		WD.T 0503.. (For DJT)	AHFM-WD0503D-D20-C20-L150-Z02 AHFM-WD0503D-D21-C20-L150-Z02
		WD.W 06T3.. (For DJT)	AHFMC-WD06T3D-D26-C25-L200-Z02 AHFMC-WD06T3D-D33-C32-L200-Z03

S Sistem Hızlı İlerlemeli Modüler Parmak Frezeler / S System Modular Highfeed End Mills (Screw Type Tools)

-°	AHFMC-WD0804	Uç / Insert	Takım Kodu / Tool Code
		WDMT 0804.. (For SMTM)	AHFMC-WD0804-D25-M12-L35-Z02-H AHFMC-WD0804-D32-M16-L35-Z03-H

S Sistem Hızlı İlerlemeli Modüler Parmak Frezeler / S System Modular Highfeed End Mills (Screw Type Tools)

-°	AHFM-WD..	Uç / Insert	Takım Kodu / Tool Code
		WD.T 0503.. (For DJT)	AHFM-WD0503D-D20-M10-L30-Z02-H AHFM-WD0503D-D25-M12-L35-Z03-H AHFM-WD0503D-D32-M16-L43-Z04-H AHFM-WD0503D-D40-M16-L43-Z05-H
		WD.W 06T3.. (For DJT)	AHFMC-WD06T3D-D35-M16-L43-Z03-H
		WD.W 0805.. (For DJT)	AHFMC-WD0805D-D32-M16-L43-Z02-H

Hızlı İlerlemeli Frezeler / High Feed Milling Tools

-°	AHFMC-WD..	Uç / Insert	Takım Kodu / Tool Code
		WDMT 0804.. (For SMTM)	AHFMC-WD0804-D040-A16-Z04-H AHFMC-WD0804-D050-A22-Z04-H
		WDMT 1205.. (For SMTM)	AHFMC-WD1205-D050-A22-Z04-H AHFMC-WD1205-D052-A22-Z04-H AHFMC-WD1205-D063-A22-Z05-H AHFMC-WD1205-D080-A27-Z06-H

Hızlı İlerlemeli Frezeler / High Feed Milling Tools

-°	AHFMC-WD..	Uç / Insert	Takım Kodu / Tool Code
		WD.W 06T3.. (For DJT)	AHFMC-WD06T3D-D042-A16-Z04-H AHFMC-WD06T3D-D050-A22-Z05-H AHFMC-WD06T3D-D052-A22-Z05-H AHFMC-WD0805D-D052-A22-Z04-H AHFMC-WD0805D-D063-A22-Z05-H AHFMC-WD0805D-D063-A27-Z05-H AHFMC-WD0805D-D066-A27-Z05-H AHFMC-WD0805D-D080-A27-Z05
		WD.W 10X6.. (For DJT)	AHFMC-WD0805D-D100-A32-Z06 AHFMC-WD10X6D-D125-B40-Z06 AHFMC-WD10X6D-D160-C40-Z07

S Sistem Hızlı İlerlemeli Modüler Parmak Frezeler / S System Modular Highfeed End Mills (Screw Type Tools)

-°	AHFM-WN09T3	Uç / Insert	Takım Kodu / Tool Code
		WNMX 09T3.. (For KRLY)	AHFM-WN09T3-D32-M16-L40-Z03-H AHFM-WN09T3-D40-M16-L40-Z04-H

Frezeleme Takımları / Milling Tools

T Kanal Frezeler / T Slot Milling

90°	ATSM90-CC..	Uç / Insert	Takım Kodu / Tool Code
	CC.. 0602..	ATSM90-CC06-D17X8-W16-L85-Z02	
	CC.. 0602..	ATSM90-CC06-D28X8-W20-L66-Z04	
	CC.. 0602..	ATSM90-CC06-D32X8-W25-L100-Z04	
	CC.. 0602..	ATSM90-CC06-D45.5X8-W25-L100-Z06	
	CC.. 0602..	ATSM90-CC06-D63X8-W32-L125-Z08	
	CC.. 0602..	ATSM90-CC06-D18X9-W16-L90-Z02	
	CC.. 0602..	ATSM90-CC06-D20X9-W16-L85-Z04	
	CC.. 0602..	ATSM90-CC06-D23X10-W20-L90-Z04	
	CC.. 0602..	ATSM90-CC06-D32X10-W25-L100-Z04	
	CC.. 0602..	ATSM90-CC06-D45X10-W32-L120-Z06	
	(For ISO)	ATSM90-CC06-D25X11-W25-L100-Z04	
	CC.. 09T3..	ATSM90-CC09-D30X12-W25-L100-Z04	
	CC.. 09T3..	ATSM90-CC09-D32X12-W25-L100-Z02	
	CC.. 09T3..	ATSM90-CC09-D32X12-W25-L100-Z04	
	CC.. 09T3..	ATSM90-CC09-D32X14-W25-L100-Z04	
	CC.. 09T3..	ATSM90-CC09-D37X16-W32-L120-Z04	
	CC.. 09T3..	ATSM90-CC09-D42X17-W32-L120-Z04	
	(For ISO)	ATSM90-CC09-D40X17-W32-L120-Z04	
	CC.. 1204..	ATSM90-CC12-D47X20-W32-L120-Z04	
	CC.. 1204..	ATSM90-CC12-D52X21-W32-L120-Z04	
CC.. 1204..	ATSM90-CC12-D50X22-W32-L120-Z04		
(For ISO)	ATSM90-CC12-D55X22-W32-L120-Z04		

Disk Frezeler / Disc Milling

90°	ASDM-SPGT	Uç / Insert	Takım Kodu / Tool Code			
		SPGT 0502..	ASDM-SPGT05-D80x6-d27-Z10			
		(For ZCC)	ASDM-SPGT05-D100x6-d32-Z12			
		SPGT 0602..	ASDM-SPGT05-D125x6-d40-Z14			
			ASDM-SPGT05-D160x6-d40-Z18			
		SPGT 0602..	ASDM-SPGT06-D80x7-d27-Z10			
			ASDM-SPGT06-D100x7-d32-Z12			
		(For ZCC)	ASDM-SPGT06-D125x7-d40-Z14			
			ASDM-SPGT06-D160x7-d40-Z16			
			ASDM-SPGT06-D200x7-d40-Z18			
90°	ASDM-CC..	Uç / Insert	Takım Kodu / Tool Code			
		CC.. 0602..	ASDM-CC06-D80x8-d27-Z10			
			ASDM-CC06-D100x8-d32-Z12			
			ASDM-CC06-D125x8-d40-Z14			
			ASDM-CC06-D160x8-d40-Z16			
			ASDM-CC06-D200x8-d40-Z18			
			ASDM-CC06-D80x10-d27-Z10			
			ASDM-CC06-D100x10-d32-Z12			
			ASDM-CC06-D125x10-d40-Z14			
			ASDM-CC06-D160x10-d40-Z16			
			ASDM-CC06-D200x10-d40-Z18			
			CC.. 09T3..	(For ISO)		ASDM-CC09-D80x12-d27-Z08
						ASDM-CC09-D100x12-d32-Z10
ASDM-CC09-D125x12-d40-Z12						
ASDM-CC09-D160x12-d40-Z14						
ASDM-CC09-D200x12-d40-Z16						
ASDM-CC09-D80x14-d27-Z08						
CC.. 1204..	(For ISO)		ASDM-CC12-D100x14-d32-Z10			
			ASDM-CC12-D125x14-d40-Z12			
			ASDM-CC12-D160x14-d40-Z14			
			ASDM-CC12-D200x14-d40-Z16			
			ASDM-CC12-D80x16-d27-Z06			
			ASDM-CC12-D100x16-d32-Z08			
			ASDM-CC12-D125x16-d40-Z10			
			ASDM-CC12-D160x16-d40-Z12			
			ASDM-CC12-D200x16-d40-Z14			
			ASDM-CC12-D80x18-d27-Z06			
			ASDM-CC12-D100x18-d32-Z08			
			ASDM-CC12-D125x18-d40-Z10			
ASDM-CC12-D160x18-d40-Z12						
ASDM-CC12-D200x18-d40-Z14						
ASDM-CC12-D250x18-d40-Z16						
ASDM-CC12-D80x20-d27-Z06						
ASDM-CC12-D100x20-d32-Z08						
ASDM-CC12-D125x20-d40-Z10						
ASDM-CC12-D160x20-d40-Z12						
ASDM-CC12-D200x20-d40-Z14						
ASDM-CC12-D250x20-d40-Z16						

T Kanal Frezeler / T Slot Milling

90°	ATSM90-SP..	Uç / Insert	Takım Kodu / Tool Code
	SPMG 050204	ATSM90-SP.05-D22.5X5-W25-L100-Z04	
	(For TGTC)	ATSM90-SP.05-D30X5-W25-L100-Z04	
	SPGT 050204	ATSM90-SPGT0502-D63X6-W32-L125-Z10	
	SPGT 090408	ATSM90-SPGT0904-D32X14-W32-L120-Z04-H	
		ATSM90-SPGT0904-D37X16-W32-L120-Z04-H	
SPGT 110408	ATSM90-SPGT1104-D47X20-W32-L120-Z04-H		
SPMG 060204	ATSM90-SP.06-D80X7-W32-L120-Z10		
(For TGTC)			
°	ATSMR-RD..	Uç / Insert	Takım Kodu / Tool Code
	RD.. 0702..	ATSMR-RD0702-D17-W16-L90-Z02	
		(For ISO)	ATSMR-RD0702-D25-W16-L90-Z03
		ATSMR-RD0702-D35-W25-L100-Z05	
	RD.. 1003..	ATSMR-RD1003-D21-W25-L100-Z02	
		ATSMR-RD1003-D80-W32-L165-Z06-H	
RD.. 12T3..	ATSMR-RD12T3-D25-W25-L100-Z02		
(For ISO)	ATSMR-RD12T3-D80-W32-L165-Z06-H		
RD.. 1604..	ATSMR-RD1604-D34-W32-L110-Z02		
(For ISO)			

konusulan
the spoken kalite...
quality...





Konya Organize Sanayi Bölgesi
Işıktepe Sk. No:6 P.K. 42250
Selçuklu / KONYA / TÜRKİYE

Tel : +90 332 239 17 57 (pbx)
Fax: +90 332 239 17 52
GPS: 37.973262 N / 32.604158 E

www.akkо.com.tr
akkо@akkо.com.tr
export@akkо.com.tr

